

TOWN OF PENETANGUIHENE

Municipal Engineering Design Standards

Nov2023

Approved by Council: January 10, 2024



Town of / Ville de
PENETANGUIHENE

Prepared For:

The Town of Penetanguishene

10 Robert Street West
P.O. Box 5009
Penetanguishene, Ontario
L9M 2G2

Prepared By:

Greenland International Consulting Ltd.

120 Hume Street
Collingwood, Ontario
L9Y 1V5
P: (705) 444 - 8805

Disclaimer:

Copyright:

TABLE OF CONTENTS

1	General Information	1
1.1	Introduction	1
1.2	Revision Information	1
1.3	Engineers Role	1
1.4	Supporting Studies	1
1.4.1	Archaeological Report	1
1.4.2	Environmental Impact Study (EIS)	2
1.4.3	Environmental Site Assessment (ESA)	2
1.4.4	Functional Servicing Report (FSR)	2
1.4.5	Geotechnical Report	2
1.4.6	Excess Soils O.Reg 406/19	3
1.4.7	Hydrogeological Assessment	3
1.4.8	Noise and Vibration Study (NVS)	4
1.4.9	Stormwater Management Report (SWM)	4
1.4.10	Stormwater Management (SWM) Operations and Maintenance Report	5
1.4.11	Traffic Impact Assessment (TIA)	5
1.4.12	Tree Inventory and Preservation Plan	5
1.4.13	Additional Reports	6
1.5	Drawing Requirements	6
1.6	Barrier-Free Consideration	6
1.7	Submission and Approvals	7
1.7.1	Site Plan Approval	7
1.7.2	External Agency Approvals	7
1.7.3	Record Drawings	8
1.8	Approved Materials	8
1.9	Reference Documents	8
1.9.1	Municipal	8
1.9.2	Provincial	9
1.9.3	Federal	9
1.9.4	Other	9
2	Engineering Submission Requirements	11
2.1	Reports and Studies	11
2.2	Plans and Drawings	12
3	Water Supply and Distribution System	13
3.1	General	13
3.2	Confirmation of Existing Capacity	13
3.3	Service Area	13
3.4	Design Flows	13
3.4.1	Residential Demands	13
3.4.2	Industrial/Commercial/Institutional (ICI)	14
3.4.3	Fire Flows	14
3.5	Watermain Sizing	15

3.6	Hazen-Williams Roughness Coefficient	15
3.7	Watermain Pressure	15
3.8	Velocities.....	16
3.9	Watermain Layout	16
3.9.1	Location within Right-of-Way.....	16
3.9.2	Minimum Depth of Cover.....	16
3.9.3	Pipe Clearance	16
3.10	Bedding and Backfill.....	17
3.11	Restraints	17
3.12	Corrosion Protection.....	17
3.13	Deflection of Watermain	17
3.14	Supporting Existing Watermains.....	17
3.15	Termination of Watermain	18
3.16	Fire Hydrants.....	18
3.17	Valves	18
3.18	Water Services	19
3.18.1	Residential Service Connection.....	19
3.18.2	Industrial/Commercial/Institutional (ICI) Service Connections.....	19
3.18.3	Park Service Connections.....	19
3.18.4	Water Meters	19
3.18.5	Backflow Prevention.....	20
3.18.6	General Notes.....	20
3.19	Tracer Wire	20
3.20	Water Sampling and Flushing Stations	21
3.21	Testing and Disinfection.....	21
3.22	Fire Department Connections.....	21
3.23	Materials	21
3.24	Water Booster Stations.....	22
3.25	Miscellaneous	22
4	Sanitary Sewer System	23
4.1	General.....	23
4.2	Confirmation of Available Capacity.....	23
4.3	Service Area	23
4.4	Design Flows	23
4.4.1	Residential	23
4.4.2	Industrial/Commercial/Institutional (ICI).....	24
4.4.3	Infiltration Allowance	24
4.5	Sanitary Sewer Design.....	25
4.5.1	Hydraulic Capacity	25
4.5.2	Pipe Size	25
4.5.3	Pipe Velocities	25
4.5.4	Pipe Slopes	25
4.5.5	Pipe Materials.....	25
4.6	System Layout	26

4.6.1	<i>Location in Right-of-Way</i>	26
4.6.2	<i>Depth of Cover</i>	26
4.6.3	<i>Sewer Separation</i>	26
4.6.4	<i>Bedding and Backfill</i>	27
4.6.5	<i>Maintenance Holes</i>	27
4.7	Forcemain	28
4.7.1	<i>Minimum Diameter</i>	28
4.7.2	<i>Velocity and Transient Analysis</i>	28
4.7.3	<i>Valves</i>	29
4.7.4	<i>Forcemain Tracer Wire</i>	29
4.8	Service Connections	29
4.8.1	<i>Residential</i>	29
4.8.2	<i>Industrial/Commercial/Institutional</i>	30
4.8.3	<i>Future Connections</i>	30
4.8.4	<i>Backflow Protection</i>	30
4.9	Inspection	30
4.9.1	<i>Maintenance Holes Inspection</i>	30
4.9.2	<i>CCTV Inspection</i>	30
4.10	Testing	31
4.10.1	<i>Deflection Testing</i>	31
4.10.2	<i>Infiltration/Exfiltration Testing</i>	31
4.10.3	<i>Continuity Testing</i>	31
4.11	Sewage Pumping Station	31
5	Stormwater Management System	33
5.1	General	33
5.2	Service Area	33
5.3	Rainfall Data	34
5.4	Minor Stormwater Conveyance System	34
5.4.1	<i>Design Calculations</i>	34
5.4.2	<i>Pipe Capacity</i>	39
5.4.3	<i>Pipe Size</i>	39
5.4.4	<i>Pipe Velocities</i>	40
5.4.5	<i>Pipe Slopes</i>	40
5.4.6	<i>Sewer Layout</i>	40
5.4.7	<i>Pipe Clearance</i>	40
5.4.8	<i>Bedding and Backfill</i>	41
5.4.9	<i>Depth of Cover</i>	41
5.4.10	<i>Maintenance Holes</i>	41
5.4.11	<i>Catchbasins</i>	43
5.4.12	<i>Storm Service Connections</i>	45
5.4.13	<i>Roof Leaders</i>	45
5.4.14	<i>Foundation Drains</i>	45
5.4.15	<i>Testing</i>	46
5.4.16	<i>Materials</i>	46
5.5	Major Stormwater Management System	46
5.5.1	<i>General</i>	46
5.5.2	<i>Stormwater Modelling</i>	46
5.5.3	<i>Over-Land Flow</i>	47

5.5.4	Approvals	47
5.5.5	Roads	47
5.5.6	Culverts/Bridges.....	47
5.5.7	Channels.....	48
5.5.8	Ditches	48
5.5.9	Watercourses.....	48
5.5.10	Appropriate Outlets.....	48
5.6	Maintenance	49
6	Stormwater Management	50
6.1	General.....	50
6.2	Stormwater Quantity and Quality Criteria.....	50
6.2.1	Water Quantity Control Criteria	50
6.2.2	Supporting Calculations and Hydrologic Modelling.....	50
6.2.3	Water Quality Control Criteria	51
6.2.4	Water Balance	51
6.3	Stormwater Management Facilities.....	51
6.3.1	SWMF Types	51
6.3.2	SWMF Water Depths	52
6.3.3	Sediment Forebay	52
6.3.4	Sediment Removal and Drying Area	53
6.3.5	Inlet Structures.....	53
6.3.6	Outlet Structures.....	53
6.3.7	Emergency Spillway	55
6.3.8	Berming.....	55
6.3.9	Maintenance Access	55
6.3.10	Geotechnical Review	56
6.3.11	Fencing and Gates	56
6.3.12	Trails	56
6.3.13	Signage	57
6.3.14	Thermal Impacts.....	57
6.3.15	Aesthetics	57
6.3.16	Facilities Planting Guidelines	57
6.3.17	Operations and Maintenance and Inspection Protocol.....	59
6.4	Manufactured Treatment Devices	60
6.5	Low Impact Development	60
6.6	Erosion and Sediment Control	61
6.6.1	General	61
6.6.2	Runoff Control.....	62
6.6.3	Temporary Sediment Control Ponds	63
6.6.4	Silt Fence.....	63
6.6.5	Vegetative Buffer Strip.....	63
6.6.6	Non-Vegetated Buffer Strip	64
6.6.7	Sediment Trap.....	64
6.6.8	Construction Site Access Mats	64
6.6.9	Topsoil and Spoil Pile Management.....	64
6.6.10	Drain Inlet and Catchbasin Protection.....	64
6.6.11	Site Dewatering	65
6.7	Natural Hazards.....	65

6.7.1	Shoreline Flood Hazard	65
6.7.2	Shoreline Erosion Hazard	65
6.7.3	Interference With a Wetland	65
7	Roads	66
7.1	General	66
7.2	Roadway Design	66
7.2.1	Roadway Classification	66
7.2.2	Geometric Road Design	67
7.2.3	Vertical Curves	67
7.2.4	Crossfall	67
7.3	Intersection Design	67
7.3.1	Geometric Intersection Design	67
7.3.2	Backfall at Intersections	68
7.3.3	Roundabouts	68
7.4	Right of Way Element Design	68
7.4.1	Roadside Ditches	68
7.4.2	Culverts	68
7.4.3	Curbs and Gutters	69
7.4.4	Subdrains	69
7.4.5	Sidewalks	69
7.4.6	Cul-de-Sacs/Dead-Ends	70
7.4.7	Driveways and Entrances	70
7.4.8	Boulevards	70
7.4.9	Bicycle Lanes and Multi-Use Trails	70
7.5	Signage and Pavement Markings	71
7.5.1	Street Name Signs	71
7.5.2	Traffic Control Signs	71
7.5.3	Pavement Markings	71
7.6	Pavement Design	72
7.7	Roadway Construction	72
7.7.1	General	72
7.7.2	Grading	73
7.7.3	Granular Materials	73
7.7.4	Proof Roll	73
7.7.5	Tack Coat	73
7.7.6	Longitudinal and Transverse Joints	73
7.8	Material specifications	74
7.8.1	Granular Materials	74
7.8.2	Hot Mix Asphalt	74
7.8.3	Concrete	74
7.8.4	HMA Testing	74
8	Traffic Control and Traffic Signals	77
8.1	General	77
8.2	Standards	77
8.3	Street Names	77
8.4	Street Signs	78

8.5	Traffic Signage	78
8.6	Testing	78
8.7	Materials	78
8.8	Traffic Calming Measures.....	78
9	Utilities	78
9.1	General.....	78
9.2	Composite Utility Plan.....	79
9.3	Utility Location	80
9.4	Utility Trench.....	80
9.5	Electric Vehicles	81
10	Canada Post	81
11	Street Lighting	81
11.1	General.....	81
11.2	Design Criteria.....	81
11.3	Light Source.....	82
11.4	Light Configuration.....	82
11.5	Materials	82
11.6	Installation	82
11.6.1	<i>Ducts.....</i>	<i>82</i>
11.6.2	<i>Cables</i>	<i>83</i>
11.6.3	<i>Fuses.....</i>	<i>83</i>
11.6.4	<i>Grounding.....</i>	<i>83</i>
11.6.5	<i>Poles</i>	<i>83</i>
11.6.6	<i>Brackets and Luminaires.....</i>	<i>83</i>
11.6.7	<i>Power Service Disconnect.....</i>	<i>83</i>
11.6.8	<i>Dimming Control</i>	<i>83</i>
12	Landscape, Tree Protection, and Parks	83
	References.....	84

TABLE OF TABLES

Table 2-1 Required Reports and Studies.....	11
Table 2-2 Required Plans and Drawings	12
Table 3-1 Watermain Pressures.....	15
Table 4-1 Hydraulic Loss Associated Drops.....	27
Table 5-1 Rainfall Intensity (mm/hr).....	34
Table 5-2 Rainfall Depth (mm).....	34
Table 5-3 Runoff Coefficient – Rural [7].....	36
Table 5-4 Runoff Coefficients - Urban - 5-yr to 10-yr Storms [7].....	36
Table 5-5 IDF Curve Parameters	37
Table 5-6 Manning's Roughness Coefficients	39
Table 5-7 Storm Sewer Minimum Easement Width	40
Table 5-8 Storm Sewer Maintenance Hole Spacing.....	42
Table 5-9 Storm Sewer Maintenance Hole Minimum Drop	42
Table 5-10 Catchbasin Maximum Spacing	44
Table 5-11 Storm Culvert and Bridge Storm Protection	47
Table 6-1 SWMF Water Depths	52
Table 6-2 SWM Facility Planting Strategy Zone	58
Table 6-3 Lot Level and Source Level Control Methods	60
Table 6-4 ESC Report and Drawing Requirements [12]	62
Table 7-1 Geometric Road Design	67
Table 7-2 Geometric Intersection Design	68
Table 7-3 Road Granular and Asphalt Depth	72
Table 7-4 Driveway Granular and Asphalt Depth	72
Table 9-1 CUP Required Information.....	79
Table 9-2 Utility Clearances	80

TABLE OF APPENDICES

Appendix A Engineering Standard Revisions
Appendix B Approved Materials List
Appendix C Standard Design Drawings
Appendix D Watermain Commissioning Procedure

PREFACE

The Town of Penetanguishene's Engineering and Design Standards were written in collaboration with the Town of Penetanguishene ('Town') and Greenland Consulting Engineers Ltd. ('Greenland')

This Manual is based on the standards, technologies, legislation, and best management practices at the time of writing. The intended use of these standards is to be a guide for designing and installing municipal infrastructure within the Town of Penetanguishene. The Town Standards are not intended to replace sound engineering principles or relieve the Engineer of their responsibility for the design.

The Town requires that all materials used for construction shall be CSA certified and in accordance with the Town's approved materials list, which is amended from time to time.

1 GENERAL INFORMATION

1.1 INTRODUCTION

The Engineering and Design Standards of the Town of Penetanguishene serve as a framework for best engineering practices in all municipal and development projects. These standards should be used in conjunction with the Town's Design Drawings and the Ontario Provincial Standard Specifications (OPSS) and Drawings (OPSD) to ensure compliance.

These standards provide general guidance and should not be considered a substitute for professional engineering judgement. The engineer remains responsible for the design and must submit any deviations from the standards to the Town for review and approval. Obtaining written confirmation from the Town is necessary before submitting any formal engineering documents.

It should be noted that the Standards may not cover every possible situation. In such cases, the Town reserves the right to interpret this manual and consult other relevant guidelines in addition to using professional engineering judgement when reviewing each project. Additionally, all materials used in construction must be CSA certified and listed on the Town's approved materials list, which can be found in **Appendix B** and is subject to amendments from time to time.

1.2 REVISION INFORMATION

The Town acknowledges that this document is subject to changes and updates. A detailed list of revisions can be found in **Appendix A**. It is the designer's responsibility to ensure that they are utilizing the most recent version of this document when performing their design work.

1.3 ENGINEERS ROLE

By Law under the Professional Engineers Act, any act of planning, designing, composing, evaluating, advising, reporting, directing or supervising that requires the application of engineering principles shall be signed and sealed by a qualified Professional Engineer who is licenced to practice in the province of Ontario.

1.4 SUPPORTING STUDIES

Please note, the supporting studies have been listed in alphabetical order.

1.4.1 Archaeological Report

The Archaeological Report will evaluate all important historical elements on the site and develop a plan to address any necessary mitigation. Additionally, the report will include a list of any historically or culturally significant structures that are considered "Built Heritage" within the affected area.

The field assessment and the report will adhere to the guidelines set by the Ontario Ministry of Culture for assessing the impact of construction on archaeological features. The report will also meet the

standards for a Phase 1 Archaeological survey. The Phase 1 report will determine if further Phase 2 and 3 surveys are necessary and make recommendations accordingly.

1.4.2 Environmental Impact Study (EIS)

The Environmental Impact Study will evaluate the planned project and identify any potential effects on the natural environment. This includes, but is not limited to, woodlots, wetlands and habitats for threatened and/or endangered species. The study will thoroughly describe any identified impacts and if necessary, provide recommendations for mitigation.

The study shall be prepared by a qualified professional.

1.4.3 Environmental Site Assessment (ESA)

An Environmental Site Assessment shall be required for all lands that are to be assumed by the Town.

In accordance with O. Reg. 153/04 as amended from time to time, when a Phase 1 ESA is required, it shall be undertaken by a “Qualified Person” (‘QP’). The report shall be compiled in accordance with O. Reg. 153/04 and in addition, shall have regard for the Canadian Standards Association (CSA) guidelines.

The report shall include, but not be limited to:

- A clear and concise statement on the QPs opinion as to whether a Phase II ESA is warranted based on the conclusions of the Phase I ESA.

1.4.4 Functional Servicing Report (FSR)

The Functional Servicing Report (FSR) will evaluate the existing and proposed utilities for all planned developments and existing sites that designed to undergo any changes. The FSR will include an analysis of the water distribution network, sanitary sewer servicing, storm sewer systems, and stormwater management features. It will also provide information on the feasibility of traffic analysis, telecommunication, natural gas, and hydro distribution utilities.

The aim of the FSR is to ensure that the sites can be serviced for the intended use. The report will identify any necessary improvements to existing infrastructure. The calculations included in the FSR will be, at minimum: water demand (domestic and fire), sanitary flows, stormwater conveyance and management and water balance if required, as well as confirmation of all pipe sizes.

The report shall be stamped and signed by a licensed professional engineer.

1.4.5 Geotechnical Report

The Geotechnical Report shall include information on subsurface conditions including soil type(s) and stratification, depth to bedrock, groundwater levels, permeability, conductivity, soil bearing capacity, and presence of any contaminants.

The report will also provide calculations and recommendations for engineered fill requirements, pipe bedding, trench backfill requirements, pavement design as well as, if necessary, building foundations, retaining walls, slope stability, and soil corrosivity. the management and disposal of excess soil in accordance with O. Reg. 406/19, as appropriate.

The Geotechnical Report shall also include a log for each of the boreholes/test pits as well as a drawing with all the locations.

The report is to be stamped by a licensed Professional Engineer or Professional Geoscientist.

1.4.6 Excess Soils O.Reg 406/19

The Project Qualified Professional ('QP') shall assess the project for management of excess soils as defined in O.Reg 406/19. Should the assessment conclude that the excess soils generated from the project area qualify for an exemption or otherwise do not trigger the Regulatory Planning Requirements ('RPR') then a statement and reasoning to the conclusion of the assessment shall be included in the Geotechnical Report or as a standalone letter. When the assessment concludes the RPR are triggered, the QP will prepare and submit the reports as outlined in O.Reg 406/19 as standalone reports.

1.4.7 Hydrogeological Assessment

The hydrogeological studies shall characterize the groundwater characteristics for the site-specific project area and comment on groundwater from a broader standpoint, surrounding the project area. At minimum, the following areas should be assessed and commented on where applicable to the project:

- Soil permeabilities and associated properties;
- Groundwater impact assessment directly or indirectly to area aquifers and zones of influence from any activity i.e. construction, dewatering, water/wastewater discharge, etc;
- Impacts on existing wells and area of influence within the project area;
- Establish and monitor the seasonal high groundwater level to determine the elevation for building foundations. Note that Groundwater readings taken in summer and winter may not be a sufficient representation of the highest groundwater elevation of the site.;
- Ministry of the Environment, Conservation and Parks (MECP) D-5-5 guidelines shall be referenced for Test wells and associated testing in accordance to address water-taking impact;
- Impacts on any affected surface water bodies; and
- Technical review of Well Head Protections Areas (WHPAs) per MECP requirements.

For general road construction and installation services, the report should consider the following:

- Depth of services and identify likely areas where dewatering will be required;
 - The rate of dewatering in relation to O.Reg 63/16 with comments on Environmental Activity Sector Registry ('EASR') requirements, or Permit to take Water ('PTTW').
 - Design to provide the required dewatering for a safe and stable trench;
 - Information relating to quality of groundwater; and
-

- The temperature of the receiving watercourse.

The hydrogeological studies shall be conducted by a qualified Professional Engineer and/or Geoscientist.

1.4.8 Noise and Vibration Study (NVS)

The Noise and Vibration study shall identify all sources of potential noise and vibration and evaluate them based on the criteria laid out in the MECP guidelines. In the event that the noise and vibration exceed the MECP criteria, a recommended list of mitigation measures shall be included.

In the event that a noise fence is proposed, the report shall include details about the location and the height of the fence that is required to achieve acceptable noise levels.

The report shall be stamped and signed by a licensed Professional Engineer.

1.4.9 Stormwater Management Report (SWM)

The Town requires the Stormwater Management (SWM) Report to be submitted alongside a complete submission package. It shall include details and supporting calculations for the associated design of the major and minor stormwater management systems, the stormwater source, conveyance, and end-of-pipe controls.

1.4.9.1 Preliminary Stormwater Management Plan

- Prepared at the Draft Plan Approval stage
- Describes the proposed drainage system
- Describes stormwater quality/quantity control facilities
- Process as it relates to the Master Drainage Plan

1.4.9.2 Final Stormwater Management Plan (Stormwater Management Report)

- Prepared at the Detailed Design stage
- Details and calculations to support Master Drainage or Environmental Management Plan, including:
 - Major and minor drainage system
 - Conveyance
 - End-of-Pipe controls (SWM facilities)

1.4.9.3 Report Content

The Stormwater Management Report shall include the following information:

- Background information;
- Pre and Post Storm Drainage Areas;
- Stormwater Management Targets and Design Criteria;
- Storm Drainage and Stormwater Management System Design;
- Stormwater Management Facility System Design;
- Review of Low Impact Development Practices and their Applicability;

- Design of End-of-Pipe Controls;
- Erosion and Sediment Control;
- Inspection and Maintenance Requirements;
- Calculations, Tables, Figures, Modeling and Drawings; and
- Operations and Maintenance Manual (Refer to **Section 6.3.17**).

1.4.9.4 Model Information

The Stormwater Management Report shall include hydrologic model parameters. All parameters are to be justified and the model input and output are required. The consultant is responsible for ensuring that the model is used as intended. The MTO Drainage Management Manual may be used as a resource.

1.4.10 Stormwater Management (SWM) Operations and Maintenance Report

The Stormwater Management (SWM) Operations and Maintenance Report (OMR) shall be a stand-alone report. Where applicable, the following information shall be required:

- Background Information;
- Stormwater Management Targets / Objectives and Design Criteria;
- Storm Drainage System Design Elements and General Description of Operation
- SWM Facility Design Elements and General Description of Operation;
- Responsibility for Maintenance Activities;
- Inspection and Maintenance Procedures;
- Monitoring Program and Performance Evaluation;
- Removal and Disposal of SWM Facility Sediment;
- Estimated Annualized Operation and Maintenance Costs;
- Primary Tables and Supporting Calculations; and
- Primary Figures and Drawings.

1.4.11 Traffic Impact Assessment (TIA)

The Traffic Impact Assessment may be a stand-alone report or be included as part of the Functional Servicing Report, depending on the size of the site and its impact on surrounding traffic conditions. At Minimum the TIA shall be in accordance with TAC guidelines and include the following:

- Traffic count data shall be current and up to date;
 - Peak hours AM and PM
 - Study Horizon Year
- Local Intersection impact review; and
- Trip Generation

1.4.12 Tree Inventory and Preservation Plan

The Tree Inventory and Preservation Plan requirements can be found in **Section 13** of this report.

1.4.13 Additional Reports

The Town may request additional reports/assessments depending on the type of project that is being proposed for new development or an existing site that is undergoing significant alteration. These reports/assessments can include, but are not limited to:

- Odour Study;
- Spill Contingency Plan; and
- Foundation Survey Report.

1.5 DRAWING REQUIREMENTS

- Cover Page
- Standard Drawings
- Draft M-Plan(s) and R-Plans(s)
- Draft Plan(s) of Subdivision
- General Notes Sheet(s)
- General Aboveground Services Plan(s)
- Sanitary Drainage Plan(s)
- Storm Drainage Plan(s)
- Sanitary & Storm Design Sheet(s)
- Water Distribution System Plan(s)
- Grading Control Plan(s)
- Composite Utility Plan(s)
- Traffic Management Plan(s) & Information
- Plan and Profile Drawing(s)
- Stormwater Management Plans(s)
- Erosion and Sediment Control Plan(s)
- Miscellaneous Detail Plan(s)
- Tree Inventory, Assessment and Preservation Plan and Detail(s)
- Landscape and Streetscape Plan(s)
- Streetlighting Plan(s)
- Service Record Sheets

1.6 BARRIER-FREE CONSIDERATION

All design projects throughout the Town of Penetanguishene must give due consideration to the Accessibility for Ontarians with Disabilities Act (AODA) and must incorporate ways to remove barriers for the public.

1.7 SUBMISSION AND APPROVALS

All submissions to the Town shall include three (3) full size hard copy and a digital copy. A submission checklist can be found in **Section 2.1**.

All submissions must conform to the Town's requirements.

- First Submission
 - Town shall circulate internally.
 - Developer responsible for circulating to external agencies (County of Simcoe, MTO, etc.) for review and approval.
- Second/Subsequent Submissions
 - A cost estimate shall be provided with the Second Submission;
 - Shall include revisions incorporating comments from the previous submission;
 - Consultant shall provide to utility companies for review and comment;
 - Consultant shall provide a letter that addresses all comments and concerns from the First Submission and a description of any changes that were made from the First Submission.
- Final Submission
 - Submitted after all comments from previous submissions have been addressed.
 - Shall include final design data and a drawing set that conforms to Town standards.

1.7.1 Site Plan Approval

See [Site Plan Approval Application Form](#) on Town's website.

1.7.2 External Agency Approvals

Additional permits may be required from External Agencies. The External Agencies should be identified during pre-consultation or the draft plan approval stage. The developer shall ensure that the requirements from the agencies listed below are met prior to the registration of the plan and/or Site Plan Approval and the commencement of any site work (including tree removals, pre-grading etc.).

- Utilities
 - Alectra Utilities Inc. and Hydro One
 - Bell Canada and Rogers
 - Enbridge Consumers Gas
- Other Agencies
 - Ministry of the Environment, Conservation, and Parks (MECP);
 - Ministry of Transportation (MTO);
 - Ministry of Natural Resources and Forestry (MNRF); and,
 - Department of Fisheries and Oceans (DFO).

1.7.3 Record Drawings

Record Drawings shall be prepared in accordance with the [PEO Guidelines](#) and submitted to the Town in the digital (unlocked) format in PDF and the latest version of CAD (AutoCAD or Civil3D) locally GPS referenced. Record drawings shall include any and all changes from the design. One (1) hard copy of the Record drawings shall be submitted in addition to a digital GIS shapefile.

1.7.4 Acceptance of Works and Assumption

Acceptance of Above Ground works, Underground works and Assumption shall be per the signed Agreements (including, but not limited to: Pre-Servicing, Subdivision, External Works, Site Plan, Plan of Condominium) between the Town and Owner.

1.8 APPROVED MATERIALS

The Town has developed a list of products that are approved for use in the Town of Penetanguishene. The Lists of Approved Materials can be found in **Appendix B**.

The Town reserves the right to remove products or add additional products if the Town has enough information to support the change.

1.9 REFERENCE DOCUMENTS

In addition to these Engineering Standards, references have been made to external documents which the designer is responsible for reviewing and ensuring all designs are in accordance with the following documents, as amended from time to time.

1.9.1 Municipal

- Town of Penetanguishene Official Plan
- Cycling Strategy
- Severn Sound Remedial Action Plan - Urban Stormwater Strategy (December 1998)
- Water Licenses (Payette and Lepage)
- Stormwater Management and Sanitary System CLI ECA's
- Community Design Manual
- Tree Planting and Management Guidelines
- By-Laws
 - Traffic/Parking By-Law 2022-02 & 2012-23
 - Sewer Connection By-Law 2013-33
 - Backflow and Cross Connection Control By-Law 2015-61
 - Site Alteration By-Law
 - Tree Cutting By-law

1.9.2 Provincial

- Ministry of the Environment, Conservation, and Parks (MECP)
 - Stormwater Management Planning and Design Manual (SWMPDM)
 - Design Guidelines for Sewage Works
 - Design Guidelines for Drinking Water Systems
 - Procedure F-6-1 Govern Separation of Sewers
 - Low Impact Development Guidance Manual (LID GM)
- Ministry of Transportation (MTO)
 - Traffic Manuals
 - Highway Traffic Act Regulations for Ontario
 - IDF Curve LookUp
 - Drainage Manual
- Ontario Traffic Manual (OTM)
 - Regulatory Signs and Warning Signs
- Highway Traffic Act
- Ontario Provincial Standard Specifications (OPSS)
- Ontario Provincial Standard Drawings (OPSD)
- Ontario Regulations (O. Reg)
- Ontario Building Code (OBC)
- Ontario Electrical Code
- Electrical Safety Authority (ESA)
- Accessibility for Ontarians with Disabilities Act (AODA)

1.9.3 Federal

- Transportation Association of Canada (TAC)
 - Guidelines for the Understanding, Use, and Implementation of Accessible Pedestrian Signals
 - A Guide to the Structural Design of Flexible and Rigid Pavements in Canada
 - Canadian Roundabout Design Guide
 - Guide for Design of Roadway Lighting
- Department of Fisheries and Ocean Canada (DFO)
- CSA Standards
- Fire Underwriters Survey (FUS)
- Insurance Bureau of Canada
- Technical Standards & Safety Authority (TSSA)

1.9.4 Other

- NVCA Pond Planting Guidelines (NVCA, April 2006)
- Native Plant Species in Ontario (Riley, 1989)

- Inspection and Maintenance Guide for Stormwater Management Ponds and Constructed Wetlands (TRCA, April 2018)
- Erosion and Sediment Control Guideline for Urban Construction (TRCA, 2019)
- AWWA Manual M31 – Distribution System Requirements for Fire Protection
- ASSE 1060 Standards
- American National Standards Institute (ANSI)
- Illuminating Engineering Society of North America (IES)
- Severn Sound Sustainability Plan, 2009

2 ENGINEERING SUBMISSION REQUIREMENTS

Submission Documents (As Required)	SUBMISSION							
	1st	2nd +		Final			Record Drawings	
	Full Size (24 x 36)	Full Size (24 x 36)	11 x 17 Copies	Signing Set	Full Size (24 x 36)	11 x 17 Copies	Full Size (24 x 36)	Digital (1)
Cover Sheet	3	3	3	2	1	3		
General Notes Sheet	3	3	3	2	1	3		
General Underground Services Plan (s)	3	3	3	2	1	3	1	×
Sanitary Drainage Plan(s)	3	3	3	2	1	3	1	×
Storm Drainage Plan(s)	3	3	3	2	1	3	1	×
Water Distribution Plan(s)	3	3	3	2	1	3	1	×
Grading Control Plan(s)	3	3	3	2	1	3	1	×
Composite Utility Plan	3	3	3	2	1	3	1	×
Traffic Management Plan(s)	3						1	×
Plan and Profile Drawing(s)	3	3	3	2	1	3	1	×
Stormwater Management Plan(s)	3	3	3	2	1	3	1	×
Erosion and Sediment Control Plan(s)	3	3	3	2	1	3	1	×
Standards Detail Plan(s)	3	3	3	2	1	3	1	
Tree Preservation Plan(s)	3	3	3	2	1	3	1	
Landscape and Streetscape Plan(s)	3	3	3	2	1	3	1	×
Streetlighting Plan(s) & Photometric Report	3	3	3	2	1	3	1	×
Sanitary & Storm Sewer Design Sheets	3	3	3	2	1			
Stormwater Management Report	3		3					
Water Distribution System Analysis Report	1		3					
Draft M-Plan	3	3	3	1	5			
Draft Easement R-Plan(s)	3	3	3	1	5			
O.L.S. Certificate of Frontages & Areas	2		3		2			
Geotechnical (Soils) Report	3		3					
Noise Report	3		3					
Archeological Report	3		3					
Phase 1 Environmental Site Assessment	3		3					
MECP Application Forms		3						
Cost Estimate for Financial Securities		2						
Individual Service Record Sheet(s)							1	×

2.1 REPORTS AND STUDIES

Table 0-1 Required Reports and Studies

Required Material	Check if Submitted
Archaeological Report	<input type="checkbox"/>
Environmental Impact Study	<input type="checkbox"/>
Environmental Site Assessment	<input type="checkbox"/>
Floodplain Analysis	<input type="checkbox"/>
Functional Servicing Report	<input type="checkbox"/>
Geotechnical Report	<input type="checkbox"/>
Hydrogeological Assessment	<input type="checkbox"/>
Hydrogeological Analysis with Water Balance	<input type="checkbox"/>
Noise and Vibration Study	<input type="checkbox"/>
Stormwater Management Report (including LIDs)	<input type="checkbox"/>

Required Material	Check if Submitted
Stormwater Management Operations and Maintenance Manual (Stand Alone)	<input type="checkbox"/>
Traffic Impact Assessment	<input type="checkbox"/>
Tree Inventory and Preservation Plan	<input type="checkbox"/>

2.2 PLANS AND DRAWINGS

Table 0-2 Required Plans and Drawings

Required Material	Check if Submitted
Cover Page	<input type="checkbox"/>
Standard Drawings	<input type="checkbox"/>
Draft M-Plan(s)	<input type="checkbox"/>
Draft R-Plans (s)	<input type="checkbox"/>
Draft Plan(s) of Subdivision	<input type="checkbox"/>
General Notes Sheet(s)	<input type="checkbox"/>
General Aboveground Services Plan(s)	<input type="checkbox"/>
Sanitary Drainage Plan(s)	<input type="checkbox"/>
Storm Drainage Plan(s)	<input type="checkbox"/>
Sanitary & Storm Design Sheet(s)	<input type="checkbox"/>
Water Distribution System Plan(s)	<input type="checkbox"/>
Grading Control Plan(s)	<input type="checkbox"/>
Composite Utility Plan(s)	<input type="checkbox"/>
Traffic Management Plan(s) & Information	<input type="checkbox"/>
Plan and Profile Drawing(s)	<input type="checkbox"/>
Stormwater Management Plans(s)	<input type="checkbox"/>
Erosion and Sediment Control Plan(s)	<input type="checkbox"/>
Pavement Marking Plan(s)	<input type="checkbox"/>
Signage Plan(s)	<input type="checkbox"/>
Phasing Plan(s)	<input type="checkbox"/>
Tree Inventory, Assessment and Preservation Plan and Detail(s)	<input type="checkbox"/>
Landscape and Streetscape Plan(s)	<input type="checkbox"/>
Streetlighting Plan(s)	<input type="checkbox"/>

3 WATER SUPPLY AND DISTRIBUTION SYSTEM

3.1 GENERAL

The developer is responsible for the installation of a Water Distribution System for potable water, including Appurtenances, Hydrants and Service Laterals to the property lines.

The water distribution system is to be designed as a network system. The design will take into account the water demand for the specified areas as well as any lands situated beyond the proposed development lands. As an added factor of safety, the system shall be looped with the design being approved by the Town.

3.2 CONFIRMATION OF EXISTING CAPACITY

The system shall be designed to provide adequate domestic, commercial, industrial and fire flows.

The Town of Penetanguishene operates and maintains a working Town wide water model. During pre-consultation and before any design work is initiated, the designer must consult with the Town regarding available capacity and pressure in the water distribution system to service the proposed development project. All information required for review will be provided by the designer.

3.3 SERVICE AREA

All new water distribution infrastructure will be designed to service the full build-out of the development. External development lands must also be taken into account for all trunk watermain designs and provide a stub where necessary. All connection points to the existing watermain are subject to approval by the Town.

3.4 DESIGN FLOWS

The Watermain shall be designed to convey the greater of the following flow scenarios:

- Maximum Day Demand plus Fire Flow; or
- Peak Hourly Demand.

3.4.1 Residential Demands

The Average Daily Demand (ADD) shall be 350 L/cap/day. The Town may consider alternate demand per capita rates based on actual consumption data.

For local watermains, the population densities below can be used to estimate residential water demands.

- Single Family and Semi-Detached: 2.4 persons/unit
- Townhouses: 2.16 persons/unit
- Apartment: 2.0 persons/unit

The designer shall use actual flow demand information from the area if it is available. If sufficient demand information is not available, the following unit densities shall be used, unless specified otherwise in the Town's Official Plan as amended from time to time:

- Single Family and Semi-Detached: 24 units/site ha
- Townhouses: 40 units/ha
- Apartment: 75 units/ha

For the design of the trunk watermains, census data or other reliable means of estimation can be used to estimate the population.

Peaking Factors can be applied to the ADD to determine the Minimum Hourly Demand (MinHD), Maximum Daily Demand (MDD) and Peak Hourly Demand (PHD). The peaking factors from the *MECP Design Guidelines for Drinking Water Systems* [1] are listed below and can be used, unless the Town specifies higher values based on the development.

- MinHD Peaking Factor: 0.60
- MDD Peaking Factor: 1.90
- PHD Peaking Factor: 2.85

3.4.2 Industrial/Commercial/Institutional (ICI)

For industrial, commercial, and institutional applications, the Average Daily Demand should be based on historical records if available. If insufficient data is available, the demands from the most recent version of *MECP Design Guidelines for Drinking Water Systems* [1] can be used. The MECP values can be seen below.

- Commercial / Institutional: 28 m³/ha/d
- Light Industrial: 35 m³/ha/d
- Heavy Industrial: 55 m³/ha/d

The peaking factor should be calculated based on historical data where possible. In the event that there is insufficient data, the calculation of Commercial and Institutional Peaking Factors shall be per MECP guidelines [1] with regard for expected daily usage time (i.e. 8-hour days).

3.4.3 Fire Flows

Fire flows are to be determined based on the most recent publication of the *Fire Underwriters Survey 2020 ('FUS')* [2] or alternatively using the *Ontario Building Code* [3].

3.5 WATERMAIN SIZING

Watermains shall be sized to provide maximum day demand plus fire flows within the Development and be compatible with the Town's overall water distribution system, including the demands foreseen for future development outside the subject Development.

For residential developments, the minimum size of the watermain shall be 150 mm in diameter. The one exception is beyond the last hydrant on cul-de-sacs, in which case the minimum diameter of watermains shall be 50mm.

For ICI developments, the minimum size of the watermain shall be 200 mm in diameter.

The Town's Public Works Department (Water Division) will conduct a hydraulic network analysis of the water distribution system. All information required for such review will be provided by the designer.

3.6 HAZEN-WILLIAMS ROUGHNESS COEFFICIENT

The Hazen-Williams formula is to be used for determining the friction losses and ultimately for sizing the watermains.

For new watermains, the Hazen-Williams roughness coefficient ('C'), shall be as follows:

$C = 140$ for 150 mm diameter

$C = 150$ for 200 mm diameter to 250 mm diameter

$C = 150$ for 300 mm diameter to 600 mm diameter

3.7 WATERMAIN PRESSURE

The acceptable limits for the pressure in the Watermain are outlined below:

Table 3-1 Watermain Pressures

Demand Condition	Preferred		Accepted	
	Minimum Pressure kPa (psi)	Maximum Pressure kPa (psi)	Minimum Pressure kPa (psi)	Maximum Pressure kPa (psi)
Minimum Hour	-	700 (101)	-	700 (101)
Maximum Hour	345 (50)	485 (70)	275 (40)	550 (80)
Average Daily Demand	345 (50)	485 (70)	275 (40)	550 (80)
Maximum Daily Demand	345 (50)	485 (70)	275 (40)	550 (80)
Maximum Daily Demand <i>plus</i> Fire	140 (20)	-	140 (20)	-

3.8 VELOCITIES

The velocities in the watermain should not exceed 5.0 m/s and should not cause unnecessary head loss. In the rare case that the velocity must exceed 5.0 m/s, a formal report and supporting calculations are required to be submitted to the Town for approval.

3.9 WATERMAIN LAYOUT

3.9.1 Location within Right-of-Way

The location of the watermain in the road right-of-way generally conforms to the Standard Road Cross-Sections provided in **Appendix C**. Where possible, watermains are also to be installed on the opposite side of the road from the hydro distribution system.

Any modifications to the layout of the watermain due to conflicts with sidewalks, utilities and/or services must be presented and approved by the Town through a Standard Deviation Request.

3.9.2 Minimum Depth of Cover

The standard and minimum depth of cover for trunk watermains and services shall be 1.7 m in all locations up to a maximum depth of 2.5 m for short lengths.

In locations where the maximum depth is exceeded or clearance from utilities or structures is required, the watermains may be designed and installed at a shallower depth if the watermain is insulated within a sleeve in accordance with the MECP standards [1] or Ontario Building Code (OBC A-7.3.5.4.) [3] approved standards for structural strength.

The minimum cover depth at culvert crossings and enclosed ditch crossings shall be measured from the culvert or ditch-pipe invert. Where watermains cross under storm sewers, the watermain depth shall be such as to provide adequate frost protection.

3.9.3 Pipe Clearance

The clearance between the Watermain and other sewers must conform to the MECP guidelines or alternatively, the MECP Procedure F-6-1 [4].

From the MECP Procedure F-6-1 [4], watermains that run parallel to other sewers must maintain a horizontal distance of 2.5 m between them. In locations where this is not possible, the pipes can be oriented vertically if the crown of the sewer is 0.5 m below the invert of the watermain. The space between the two pipes must be filled with in situ material or compacted backfill such that joint deflection and settling are eliminated. Joints should be offset as much as possible between sewers and watermains.

If it is not possible to achieve the horizontal or vertical separation distances outlined above, one of the following methods should be used.

- The sewer should be designed and constructed to the specification of the watermain and be pressure tested at 350 kPa (50 psi) to assure water tightness; and/or

- Either the sewer or the watermain should be encased in a watertight carrier pipe which extends 3m on both sides of the crossing, measured perpendicular to the watermain.

3.10 BEDDING AND BACKFILL

All new watermain and associated infrastructure must be placed in accordance with OPSS.MUNI 410. All bedding and backfill material must be approved by the Geotechnical Engineer and the Town. Backfill must be completed following the procedure specified within OPSD 802.010 or 802.030 to 802.032, as applicable. The backfill will also be compacted in lifts to a minimum of 95% SPD or as directed by the Geotechnical Engineer.

3.11 RESTRAINTS

Thrust protection at bends and tees, including hydrant branches, ends of watermain and connections 100 mm and larger shall be mechanically restrained joints, designed, and installed in accordance with the manufacturer's recommendations and as per OPSD 1103.010 and OPSD 1103.020. The engineering drawings shall have a table included to show the length of the pipe/number of joints that are to be mechanically restrained at restrained locations. The EBAA Pipe Joint Restraint Calculator available at <http://rcp.ebaa.com/> or equivalent is to be used to establish the information in the table.

All watermain and thrust restraints shall be designed to withstand the maximum operating pressure, plus the transient pressure. The value of transient pressure will be greater than the pressure surge that would be caused by a water column, moving 0.6 m/s being abruptly stopped.

3.12 CORROSION PROTECTION

Petrolatum Tape meeting CSA standards shall be used on all exposed bare metal surfaces including, but not limited to (bolts, caps, Mechanical Joints, any location where the protective coating is damaged or otherwise removed, etc.)

3.13 DEFLECTION OF WATERMAIN

In the event that the watermain needs to be deflected to avoid conflict with other infrastructure, the designer shall provide detailed drawings and calculations for such deflection to the Town for approval.

For vertical bends, the minimum length of deflected watermain is 1.5 m and the maximum vertical bend shall be 45°.

3.14 SUPPORTING EXISTING WATERMAINS

If the construction work requires uncovering more than 1 m of an existing watermain, the designer will have to develop a plan to support the watermain during construction. This plan, along with the necessary details and drawings, must be submitted to the Town for review and approval.

3.15 TERMINATION OF WATERMAIN

In the locations where dead-end watermain pipe is allowed, the watermains shall be fitted with a valve and hydrant or a 50 mm (minimum) diameter blow-off and installed per **Town Standard Dwg. 3.1** as seen in **Appendix C**.

3.16 FIRE HYDRANTS

All Fire Hydrants shall be installed according to OPSD 1105.010 and are to be completed with mechanical restrainers and raised to grade.

The Standard Road Cross-Sections provided in **Appendix C**, are to be consulted when determining the location of fire hydrants. Other typical locations for fire hydrants are on projections of lot lines, at the end of all cul-de-sacs, and dead ends. For hydrants positioned behind ditches, access shall be provided as per OPSD - 217.050.

Hydrants shall be spaced at intervals not exceeding 150 m in residential developments and 90 m in commercial and industrial developments or as required by the Town. This length is to be measured along the watermain alignment. Hydrants may also be located at dead-end watermains and high points in the watermain system (instead of air release valves).

Fire Hydrants shall be equipped with a 'Storz' style pumper port.

3.17 VALVES

Valve Spacing

For distribution watermains, valves shall be spaced every forty (40) dwelling units or 300 m (whichever is fewer). For trunk watermains, the maximum allowable spacing shall be 400 m.

Valve Boxes and Chambers

Valve boxes are required on watermain up to 375 mm in diameter. One exception is at a high point in the watermain, in which case a chamber may be required with the air release valve. Valves on watermains that are larger than 400 mm in diameter will require a drain valve in a chamber.

Water-Proofing of Valve Chambers

The joints of all valve chambers are to be waterproofed with a membrane or petrolatum tape. The membrane shall be installed as per the manufacturers' specifications and protected during backfill operations.

Air Release Valve

At all high points in the trunk watermain, air release valves shall be provided. Where possible, a valve (in a valve chamber) will be installed with it. In addition, if feasible, fire hydrants shall be located at all high points to minimize the negative impacts of trapped air.

Drainage Valve

Drain valves must be placed at all low points in the trunk watermain. When feasible, valves (in valve chambers) will be included with the installation. Drainage Chambers must be connected to a storm sewer manhole or an approved discharge location.

Pressure Reducing Valve

A pressure-reducing valve complete with a chamber may be required in certain watermain networks. Water modelling calculations are to be used to determine if such a valve is required. Detailed requirements will be confirmed by the Town at the time of completion of the water modelling report.

3.18 WATER SERVICES

3.18.1 Residential Service Connection

For single-family residences, the service lateral will have a minimum internal diameter of 25 mm with a curb stop at 0.3 m in front of the property line and is to be installed to each residential property. Water services shall be located at a minimum depth of cover of 1.7 m with the curb stop being at least 1.0 m away from the future driveway. If it is found that the curb stop must fall within the driveway area due to conflicts with other infrastructure, a frost collar will be required.

The pipe material for residential service laterals is Municipex, this information can also be found in **Appendix B**.

3.18.2 Industrial/Commercial/Institutional (ICI) Service Connections

The diameters for service laterals for multi-residential, commercial, and industrial units shall be appropriately selected by the Developer's Consulting Engineer and approved by the Town. The location of water service connections for commercial, institutional, or industrial use will be considered on an individual basis.

The pipe materials for service laterals for multi-residential, commercial, and industrial units shall be appropriately selected by the Developer's Consulting Engineer.

3.18.3 Park Service Connections

Park areas shall have water services that are installed with a non-freeze post hydrant. The service size is to be a minimum of 25 mm in diameter. However, the actual size of the service will be confirmed during the design process based on the type of facilities being installed in the park.

3.18.4 Water Meters

All water that is sourced from the Town's watermain is to be metered. The Town is responsible for sizing the water meter based on peak instantaneous flows that are to be provided by the designer.

The Town is responsible for providing and installing all water meters up to and including 50 mm. The Developer/Owner must contribute to the cost of the meter, the inspection fees, and any other associated fees (e.g. tapings), prior to the meter being installed.

The location of all water meters must be reviewed and approved by the Town, accessible at all times and installed in a horizontal position within the mechanical room.

Meters that are 38 mm or larger may require a bypass. These by-passes are only to be operated by authorized Town Representatives and must come with lockable anti-tampering devices. Operation by anyone else will result in the disruption of service and/or charges being levied.

3.18.5 Backflow Prevention

All water service laterals to residential, industrial, commercial, institutional, multi-use buildings etc. within the Town's watermain network, will be fitted with a premise Backflow Preventor, regardless of its size. The Backflow Preventor is to be installed downstream of the water meter or in the case of a fire protection system, where the fire protection system enters the building.

All Backflow Preventers and Water Meters to Industrial, Commercial, Institutional or Multi-use buildings that are not housed within the facility are to be fitted with prefabricated enclosures. Above-grade enclosures are to be insulated and heated so that the temperature remains above freezing and in accordance with ASSE 1060 Standards. Below-grade enclosures are to be sealed in a subterranean chamber with a DCVA backflow preventer.

All backflow prevention devices, appurtenances and enclosures must be selected and maintained in accordance with the manufacturer's specifications, and the guidelines set out in the most recent version as well as AWWA, Town of Penetanguishene Cross Connection Control By-Law (as amended from time to time), CSA Standards, Ontario Building Code, and applicable Provincial Regulations.

3.18.6 General Notes

When the water service line conflicts with any main service pipe (typically storm sewer main), the water service must be installed below the storm sewer with separation as required by MECP. The creation of high points along the water service line is not allowed, with the exception of horizontal goosenecks, established near main stops.

3.19 TRACER WIRE

Tracer wire is to be installed on all watermains, hydrant laterals and water services. The tracer wire shall be installed such that all watermains, hydrant laterals, and water services can be traced using industry-standard locating equipment.

Tracer wire shall be #12 TWU stranded and insulated with a 30 mm high-density polyethylene (HDPE) insulation that is rated for direct burial use at 30 volts. The tracer wire shall not be wrapped around bolts or components along the mainline and shall not be placed under any pipe or appurtenance. Tracer wire

shall be placed flush against the pipe and securely fastened with mastic tape at a minimum of 5m intervals to the top of the watermain.

Tracer wire ends are required to be connected via a waterproof marrette.

In the event that a non-metallic main needs to be connected to metallic mains, the tracer wire must be bonded via cadweld or tie down straps completely covered in rubberized anti-rust coating, to the metallic main. All welding locations are to be sealed with an approved metallic sealant for underground use. The sealant is to be applied in a 12 mm coat and protected with a plastic membrane during backfill.

In the event that more than one watermain exists on a single street (i.e. a transmission main and a distribution main), the tracer wire must daylight at a test station every 350 m or less. Tracer wire running from the mainline to a connection post shall be in a 1" rigid PVC conduit. The test station shall be installed 1.0 m to 1.2 m above grade and shall be colour-coded blue.

In the event that a watermain is directionally drilled, the tracer wire is to be installed with the pipe during installation.

Refer to **Appendix B** for a list of approved materials and specifications.

3.20 WATER SAMPLING AND FLUSHING STATIONS

The Town will require water sampling stations as needed. Common practice is to provide one (1) sampling station for every three hundred (300) units. Sampling stations are to be located within municipal ROW or in a corner area of municipal blocks (e.g. parks, parkettes). They are not to be located in intersection areas.

3.21 TESTING AND DISINFECTION

Watermains, including service laterals, shall be disinfected and tested in the presence of Water Division staff and in accordance with the Town's Watermain Commissioning Plan. This file is available upon request from the Town.

Permissible rates of leakage are as specified in OPSS.MUNI 441. Documented test results shall be delivered to the Town. Dechlorination of the watermain will be done using a Town approved chemical agent (i.e. sodium thiosulphate tablets). The dechlorination procedure shall be presented to the Town for approval prior to the commencement of the dechlorination procedure.

3.22 FIRE DEPARTMENT CONNECTIONS

ICI developments may require designated fire department connections. During pre-submission consultation, the configuration of the fire and domestic water service connections are to be approved by the Town.

3.23 MATERIALS

The current approved material list is available upon request from the Town.

3.24 WATER BOOSTER STATIONS

Water Boosting Stations are to be designed to maintain the quality of the water that is pumped through the system.

3.25 WATERMAIN THROUGH CONCRETE CHAMBER

Any watermain required to pass through a concrete chamber shall be Ductile Iron or a PVC / HDPE pipe inside an iron sleeve complete with manufacturer approved material filling the void space.

3.26 MISCELLANEOUS

- Ontario Provincial Standard Details are applicable except as altered by the Water Division Standards. Revised details can be found in **Appendix C**. Copies of the applicable Standard Drawings are to be included in the Engineering Drawings for the Development;
- At all locations where newly constructed watermains are to be connected to the Town's existing watermain network, such connections shall be made utilizing:
 - The "New Watermain Temporary Connection" is detailed in **Appendix C**.
 - Figure A-3 and Figure A-4 from the Ontario Watermain Disinfection Procedure [5] can also be referenced.
- The Town requires applicants to fill out Form 1 for all watermain, including private condominium complexes.

4 SANITARY SEWER SYSTEM

4.1 GENERAL

The Developer is responsible for the installation of a Sanitary Sewage Collection System, including Pump Stations, Appurtenances and Service Laterals to property lines to service the proposed Development.

An agreement with the Director of Public Works shall be obtained by the Developer regarding the design and construction requirements for project specific sanitary collection structures such as lift and pump stations.

The System shall be designed to accommodate the flows generated within the proposed Development and the flows which are presently or will be in the future, generated on lands upstream of the proposed Development. The Developer will be responsible for the examination of the downstream Sanitary Sewer System to ensure that the flows generated by the proposed Development can be accommodated. The elimination of restrictions in the downstream collection system will be the subject of negotiations with the Town.

All sanitary works are to be in conformance with the Town of Penetanguishene Sewer use By-Law, as amended from time to time.

4.2 CONFIRMATION OF AVAILABLE CAPACITY

The Town of Penetanguishene operates and maintains a working Town wide sanitary network model. During pre-consultation and before any design work is initiated, the designer must consult with the Town regarding available capacity in the sanitary sewer network to service the proposed development project. All information required for review will be provided by the designer.

4.3 SERVICE AREA

All new sanitary sewer infrastructure will be designed to service the full build-out of the development. External development lands must also be taken into account. All connection points to the existing sanitary sewer are subject to approval by the Town.

4.4 DESIGN FLOWS

The sanitary sewer system is to be designed to convey the peak flows from all residential, commercial, institutional, and industrial areas, plus extraneous flow from groundwater and surface water sources.

4.4.1 Residential

The Average Daily Sewage generation rate is to be 350 L/persons/day. The Town may consider alternate demand per capita rates based on actual consumption data.

For local sanitary sewers, the population densities below shall be used to estimate residential sewage demands.

- Single Family and Semi-Detached: 2.4 persons/unit
- Townhouses: 2.16 persons/unit
- Apartment: 2.0 persons/unit

If insufficient information is available, the following unit densities shall be used, unless specified otherwise in the Town's Official Plan.

- Single Family and Semi-Detached: 24 units/site ha
- Townhouses: 40 units/ha
- Apartment: 75 units/ha

For the design of the trunk sanitary sewer, census data or other reliable means of estimation can be used to estimate the population.

The Harmon Peaking Formula shall be used to calculate the Peaking Factor, unless otherwise specified in the standard flow rate. The Peaking Factor is to be applied to the domestic average daily sewage flows.

$$M = 1 + \frac{14}{4 + P^{0.5}}$$

Where:

M = Harmon Peaking Factor

P = Population, in thousands

4.4.2 Industrial/Commercial/Institutional (ICI)

For industrial, commercial, and institutional applications, the Average Daily Sewage generation rates should be based on historical records if available. If insufficient data is available, refer to the *MECP Design Guidelines for Sewage Works* Section [6] 5.5.2.2. (*Table 5-3 – Common Sewage Flow Rates for Commercial and Institutional*) and Section 5.5.2.3. for Industrial standard sewage flow values.

If insufficient information is available for commercial and tourist areas, a value of 28 m³/ha/d may be used as an average sewage flow rate.

In the event that specific land use data or sewage generation information is available, the Town has the authority to allow or impose alternative standards.

The Minimum Peaking Factor shall be 2.0 and the Maximum Peaking factor shall be 4.0.

4.4.3 Infiltration Allowance

An infiltration allowance of 20,000 L/ha/d (0.23 L/s/ha) shall be applied to all lands that contribute to the sewage flows.

4.5 SANITARY SEWER DESIGN

4.5.1 Hydraulic Capacity

Manning's Equation (for pipes flowing full) shall be used to calculate the hydraulic capacity of the sanitary sewer.

$$Q = \frac{1}{n} \cdot A \cdot R^{2/3} \cdot S^{1/2}$$

Where:

Q = capacity of the pipe (m^3/s)

n = manning roughness coefficient (dimensionless)

A = cross – sectional area of the pipe (flowing full: $A = \pi \cdot D^2/4, m^2$)

D = nominal diameter of the pipe (m)

R = hydraulic radius of the pipe (flowing full: $R = D/4, m$)

S = slope of the pipe (m/m)

4.5.2 Pipe Size

4.5.3 The minimum pipe size for sanitary sewers is 200 mm in diameter. The diameter of the downstream pipe in a sanitary sewer system must be equal to or greater than that of the largest upstream pipe. Pipe Velocities

Sanitary sewer pipes must sustain a velocity such that the self-cleaning nature of the pipe is preserved.

The minimum velocity under ultimate design peak flow shall be 0.6 m/s and the maximum velocity shall be 3.0 m/s.

4.5.4 Pipe Slopes

The minimum pipe slope of the furthest upstream sewer segment shall not be less than 1.0%. Pipe slopes for the remainder of the system shall be designed to achieve self-cleaning and maximum velocities per Section 4.5.3.

4.5.5 Pipe Materials

4.5.5.1 Trunk Sewer

Trunk Sanitary Sewer pipe 600mm dia. and smaller shall be Polyvinyl Chloride (PVC) SDR 35 with a minimum strength of 320kPa or greater as determined by the design. For sewer sizes over 600mm dia. concrete sewer is acceptable. Alternative trunk sewer material types will be reviewed on a case-by-case basis upon application from the design engineer along with all supporting information.

4.5.5.2 *Service Lateral*

Service lateral material shall be SDR 28 with a minimum strength of 630 kPa for service laterals.

4.5.5.3 *Forcemain*

Forcemain material shall be HDPE with a minimum strength of 320 kPa or higher as determined by forcemain pressure calculations

4.6 SYSTEM LAYOUT

4.6.1 Location in Right-of-Way

The location of the sanitary sewer in the road right-of-way is to conform to the Standard Road Cross-Sections provided in **Appendix C**. Manholes are to be located outside of the wheel track of lanes whenever possible and shall be a minimum of 1.0 m from all curb faces and/or services.

4.6.2 Depth of Cover

A minimum depth of cover of 2.70 m at the property line must be provided to connect to basement floor drains using a pipe that is installed at a minimum 2% slope.

In the event that the minimum depth of cover is not able to be met, the Town may approve the use of insulation in accordance with the Ontario Building Code (OBC A-7.3.5.4.) [3].

4.6.3 Sewer Separation

The clearance between the Sanitary Sewers and other underground pipe infrastructure must conform to the MECP guidelines [6] or alternatively, the MECP Procedure F-6-1 [4].

From the MECP Procedure F-6-1 [4], sewers that run parallel to other watermains or sewers must maintain a horizontal distance of 2.5 m between them. In locations where this is not possible, the pipes can be oriented vertically if the crown of the watermain is 0.5 m below the invert of the sewer. The space between the two pipes must be filled with in situ material or compacted backfill such that joint deflection and settling are eliminated. Joints should be offset as much as possible between sewers and watermains.

In situations where a sewer and a watermain must cross, it is suggested that they cross perpendicularly, with the watermain above the sewer whenever possible. As stated above, the minimum vertical distance between the sewer and the watermain must be 0.5 m with the space between the pipes being filled with in situ material or compacted backfill such that deflection of the joints and settling is eliminated.

If it is not possible to achieve the horizontal or vertical separation distances outlined above, one of the following methods should be used:

- The sewer should be designed and constructed to the specification of the watermain and be pressure tested at 350 kPa (50 psi) to ensure water tightness; and/or
- Either the sewer or the watermain should be encased in a watertight carrier pipe which extends 3.0 m on both sides of the crossing, measured perpendicular to the watermain.

4.6.4 Bedding and Backfill

All bedding and backfill material are to be OPSS Granular 'A' or an equivalent approved by the Geotechnical Engineer and the Town. Backfill must be completed following the procedure specified within OPSD 802.010 or 802.030 to 802.032, as applicable. Native backfill is to be compacted in maximum 300 mm lifts to a minimum of 95% SPD or as directed by the applicable approved Geotechnical Report.

4.6.5 Maintenance Holes

All sanitary sewer maintenance holes shall conform to the newest details of OPSD 701, Benching per OPSD 701.021, Frost Straps per OPSD 701.100 and other relevant OPSS and OPSD standards, as amended from time to time.

4.6.5.1 Maintenance Hole Size

Maintenance Holes shall be precast units with a minimum size of 1,200 mm diameter.

4.6.5.2 Location and Spacing

A manhole shall be placed at the end of each line, between any change in pipe size or material, at any sudden change in grade or alignment, and at the interface of the new and existing pipe. A maintenance hole is required on the private property side for sanitary services to all ICI properties. Town approval is required for all proposed curved or deflected pipes.

Maintenance manhole shall be placed a maximum of 100 m apart for all pipe sizes, unless otherwise approved by the Town.

4.6.5.3 Hydraulic Loss

To offset hydraulic losses, a drop is required across all maintenance holes. See the table below for minimum drop allowances:

Table 4-1 Hydraulic Loss Associated Drops

Change in Direction*	Minimum Drop
Straight Run (0°)	0.03 m
1° – 45°	0.05 m
45° – 90°	0.08 m
<i>*Note: 90° is the maximum permitted change in direction.</i>	

In the event that a drop of 0.9 m or greater is required, an external "tee" (OPSD 1003.010) or "wye" (OPSD 1003.020) drop structure is required. No Internal Drop Structures will be permitted.

4.6.5.4 Rims and Lids

Maintenance Holes within the travelled part of the roadway shall be fitted with a rim that is set flush with the base course asphalt and/or top course asphalt. A maximum of 300 mm vertical adjustment using modular rings is permitted to raise the frames to the final grade. Pre-cast concrete riser sections are to be used if the adjustment height exceeds 300 mm. Maintenance holes rims and lids are to be installed according to the applicable OPSS and OPSD. Auto-stable maintenance hole lids are required on all slopes including metal ring inserts for final asphalt.

4.6.5.5 Adjustment Units

All Maintenance Hole adjustment units shall be HDPE per OPSD 704.011

4.6.5.6 Waterproofing

A waterproofing membrane shall be required at all MH joints at or at the discretion of the Town. .

Blueskin, Mel-Rol or Petrolatum Tape/Mastic or other sealant approved by the Town shall be specified to prevent groundwater infiltration.

Connections to all Maintenance holes shall be Kor-n-Seal.

Watertight Tees are required for all service lateral connections to existing sewer mains where the seasonally high groundwater is at or above the trunk main.

4.6.5.7 Frost Straps

Frost Straps are to be installed per OPSD 701.100.

4.6.5.8 Safety Platforms

Safety platforms shall be per OPSD 404.020.

4.6.5.9 Miscellaneous

The obvert of the inlet pipes shall not be lower than the obverts of the outlet pipes.

Floor drains are to be connected to the sanitary sewer. Foundation drains, roof leaders and sump pumps are not to be connected to the sanitary sewer.

4.7 FORCEMAIN

4.7.1 Minimum Diameter

All sanitary forcemains must have a minimum diameter of 75 mm, unless otherwise approved by the Town.

4.7.2 Velocity and Transient Analysis

The velocity in a forcemain shall range from 0.6 m/s to 3.0 m/s to ensure the suspension of solids, as per the *MECP Design Guidelines Sewage Works Section 7.9.1* [6].

The forcemain must be able to handle the design pressure along with the pressures associated with any sudden surge within the main. A transient analysis is required for all forcemain over 150 mm diameter and must be submitted with the design brief.

4.7.3 Valves

4.7.3.1 *Emergency Valve Connections*

Emergency valves shall be installed on the forcemain, downstream from all pump stations. This will allow for bypassing the sewage pumping station in the event of maintenance or an emergency.

4.7.3.2 *Air Release Valves*

At all high points along the forcemain, a low-pressure air release valve, or the approval equivalent, shall be installed. The designer may also propose vacuum relief valves in certain scenarios.

4.7.3.3 *Drain Valves*

In the event of a long forcemain, or in areas that are difficult to access and subject to Town approval, drain valves can be proposed at low points in the forcemain on a case-by-case basis.

4.7.4 Forcemain Tracer Wire

Tracer wire is to be installed along the sanitary forcemain for location purposes. The tracer wire shall be brought to the surface every 300 m using a testing station. All test stations are to be shown on the design drawings.

Tracer wire shall be #12 TWU stranded and insulated with a 30 mm high-density polyethylene (HDPE) insulation that is rated for direct burial use at 30 volts. The tracer wire shall not be wrapped around bolts or components along the mainline and shall not be placed under any pipe or appurtenance. Tracer wire shall be laid flat and securely affixed with mastic tape to the top of the sanitary main at 5.0 m intervals.

Tracer wire ends are required to be connected via a waterproof marrette.

In the event that a sanitary main is directionally drilled, the tracer wire is to be installed with the pipe during installation.

Refer to **Appendix B** for a list of approved materials and specifications.

Engineering submissions to the Town shall include completed sewer design sheets for the sanitary system.

4.8 SERVICE CONNECTIONS

4.8.1 Residential

Residential sanitary service lateral connections shall be installed according to the Town of Penetanguishene's standards drawings and OPSD 1006.010 and 1006.020. In the event the sanitary service lateral is required in a non-standard location, design drawings (plan and profile) showing the proposed location are to be provided to the Town for approval.

Sanitary Service Laterals shall be a minimum of 125 mm diameter for a single-family dwelling and 150 mm diameter for a duplex dwelling with a minimum slope of 2% and 2.70 m of cover at the property line. The service lateral connection to the main sewer shall be completed with a “tee” from the Town list of approved materials and manufacturers.

4.8.2 Industrial/Commercial/Institutional

All Industrial/Commercial/Institutional (ICI) sanitary lateral connections are to be designed based on the property’s intended use and approved by the Town on an individual basis. The service location and details must be shown on plan and profile drawings and grading control plans. The minimum pipe diameter and slope are 150 mm and 2% respectively.

An inspection maintenance hole (min 1500 mm diameter) is required on the private side of the property line for all ICI properties. The depth of cover at the property line must allow for the property to be serviced by a gravity system & frost depth wherever possible.

4.8.3 Future Connections

In the event that a sanitary sewer is stubbed, a sanitary maintenance hole is to be installed to allow for future connections to be made to the system.

4.8.4 Backflow Protection

Mainline Full-Port Backwater Valves or approved equivalent shall be installed inside the building on the Sanitary Service Lateral. Backwater Valves on Sanitary Service Laterals having a diameter greater than 125 mm shall be subject to discussion and acceptance with and by the Town Public Works Department and Building Department. Details of Mainline Backwater Valve Products may be found in the Town’s list of approved materials and manufacturers in **Appendix B**.

4.9 INSPECTION

4.9.1 Maintenance Holes Inspection

All maintenance holes shall be visually inspected by the Town or a representative appointed by the Town.

4.9.2 CCTV Inspection

All new sanitary sewers including mains, laterals, and maintenance holes, shall undergo a CCTV inspection in accordance with OPSS.MUNI 409. A digital copy of the CCTV videos shall be provided to the Town for review and approval. Upon their review, if the Town deems any section of the sanitary sewer unacceptable, it shall be repaired/replaced to the satisfaction of the Town and be CCTV inspected again.

4.10 TESTING

4.10.1 Deflection Testing

All newly installed PVC sanitary sewers shall be flushed/cleaned prior to the deflection test. The deflection test is to be completed in accordance with OPSS.MUNI 410. Any deficiencies must be rectified before the maintenance period can commence. A Deflection Testing report shall be provided to the Town.

4.10.2 Infiltration/Exfiltration Testing

Sewer Infiltration or Exfiltration test shall be conducted on all newly installed sanitary sewers in accordance with OPSS.MUNI 410 is based on the groundwater elevations identified through the Geotechnical Report (if applicable) and/or conditions discovered through the course of Construction.

Manholes shall be leakage tested in accordance with OPSS.MUNI 407 at the discretion of the Town.

Sanitary Sewer Infiltration testing and Manhole Testing Report is to be provided to the Town.

4.10.3 Continuity Testing

A continuity test shall be performed by a certified private locating company to ensure there was no damage to the tracer wire. If any deficiencies are found, the Contractor/Developer is responsible for the repair at no cost to the Town. A written certificate for a successful continuity test must be presented to the Town. The continuity test must be witnessed by a Town certified operator.

4.11 SEWAGE PUMPING STATION

All sewage pumping stations must be designed in accordance with the current MECP guidelines.

For all Sewage Pumping Stations ('SPS') a design brief detailing all design features of the SPS shall be provided and includes but is not limited to the following information:

- Type of pump station (wet well/dry well, submersible, lift etc.)
- Design flow calculations
- Total Static Head Calculations
- Total Dynamic Head Calculations
- Total Cycle Time
- Pump Selection
- Pump Rating Curve
- Forcemain Sizing Calculations
- Forcemain Velocity Calculations
- Emergency Storage
- Access / Egress
- Stormwater 100-Year Analysis
- Back-Up Power

- Control Centre
- Controls/ Alarms
- Emergency Overflow
- Backflow prevention
- Inlet Grinder
- Geotechnical information related to groundwater and uplift.

5 STORMWATER MANAGEMENT SYSTEM

5.1 GENERAL

The Stormwater Management System is to be designed to mitigate the effects of urbanization on the hydrologic cycle. Urbanization causes increased runoff, and decreased infiltration of precipitation. The Ministry of the Environment Conservation and Parks (MECP) Stormwater Management Planning and Design Manual (SWMPDM) lays out the following negative impacts of uncontrolled runoff on the built and natural environment; “Without proper stormwater management: reduced baseflow, degradation of water quality, and increased flooding and erosion can lead to reduced diversity of aquatic life, fewer opportunities for human uses of water resources, and loss of property and human life” (MECP, 2003).

The stormwater management system for a site can generally be broken down into 3 components:

- Minor Conveyance System - which consists of a network of below-grade gravity storm sewers, that intake surface water and transports it to a stormwater management facility or natural water features. It should be designed to ensure the safety of pedestrians and traffic during more frequent, less intense rainfall events. Minor conveyance systems in the Town shall be designed to convey the 1:5-year return frequency storm peak flow without surcharging to the surface;
- Major Conveyance System – which consists of above-grade, overland flow routes designed to convey the stormwater runoff from more extreme, less frequent events. The overland flow routes typically follow the road network and direct flow to stormwater management facilities or suitable outlets. The major conveyance system serves as a backup for when the minor conveyance system becomes overwhelmed or fails. Major conveyance systems in the Town shall be designed to safely convey the greater of the regional storm or 1:100 return frequency storm peak flow while allowing for safe access and egress; and
- Stormwater Management Facilities – which provide quality and/ or quantity control for drainage which is directed to them. Typically, stormwater management facilities receive flow via upstream minor and major conveyance systems and discharge to a suitable outlet.

5.2 SERVICE AREA

All new stormwater management systems shall be designed to service all upstream drainage catchment areas, including external tributaries. Interim and ultimate conditions are to be considered in the design process.

All connection points to the existing storm sewer are subject to approval by the Town. All discharge points to natural water features are also subject to Town approval. The Town may require upgrades to receiving water features to safely convey tributary drainage.

5.3 RAINFALL DATA

The stormwater management system shall be designed based on peak flows calculated with the intensity duration frequency (IDF) information presented in **Table 5-1** and **Table 5-2**. The IDF information was taken from the [MTO IDF Curve Lookup](#) tool and increased by 15% to account for future potential climate change.

Location: 44° 46' 15" N, 79° 56' 15" W (44.770833, -79.937500)

IDF Curve Year: 2010

Table 5-1 Rainfall Intensity (mm/hr)

Return Frequency	Duration								
	5-min	10-min	15-min	30-min	1-hr	2-hr	6-hr	12-hr	24-hr
1:2-year	138.5	85.3	64.3	39.6	24.4	15.1	7.0	4.3	2.6
1:5-year	184.2	113.5	85.4	52.7	32.4	20.0	9.3	5.8	3.6
1:10-year	214.9	132.4	99.7	61.4	37.8	23.3	10.8	6.7	4.1
1:25-year	252.8	155.7	117.3	72.2	44.5	27.4	12.8	7.8	4.8
1:50-year	280.8	173.1	130.3	80.3	49.5	30.5	14.1	8.7	5.4
1:100-year	309.0	190.3	143.4	88.3	54.4	33.5	15.5	9.5	5.9

Table 5-2 Rainfall Depth (mm)

Return Frequency	Duration								
	5-min	10-min	15-min	30-min	1-hr	2-hr	6-hr	12-hr	24-hr
1:2-year	11.5	14.3	16.1	19.8	24.4	30.0	41.9	51.5	63.5
1:5-year	15.3	18.9	21.4	26.3	32.4	39.9	55.7	68.5	84.4
1:10-year	17.9	22.1	25.0	30.7	37.8	46.6	64.9	79.9	98.4
1:25-year	21.0	26.0	29.3	36.1	44.5	54.9	76.4	94.1	115.8
1:50-year	23.5	28.9	32.5	40.1	49.5	61.0	84.8	104.4	128.7
1:100-year	25.8	31.7	35.9	44.2	54.4	67.0	93.3	114.9	141.6

5.4 MINOR STORMWATER CONVEYANCE SYSTEM

The minor stormwater management system must be able to safely convey at minimum the 1:5-year storm peak flow without surcharging. All minor stormwater conveyance infrastructure shall be in adherence to the most current Town of Penetanguishene Sewer Use By-law, as amended from time to time.

5.4.1 Design Calculations

Minor drainage systems shall be sized to convey peak flows calculated by the Rational Method, see the Rational Method equation below.

$$Q = 0.0028 * C * i * A$$

Where:

$$Q = \text{design flow (m}^3/\text{s)}$$

$$C = \text{runoff coefficient (dimensionless)}$$

$$i = \text{average rainfall intensity (mm/hr)}$$

$$A = \text{drainage area (ha)}$$

The Runoff Coefficient (C) in the Rational Method equation shall be a weighted average for the different land use and/or different soil types within the drainage area. The weighted average runoff coefficient shall be calculated using the equation below and the values presented in **Table 5-3** and **Table 5-4** which are derived from the MTO Drainage Manual.

$$C = \frac{(A_1 * C_1) + (A_2 * C_2) + \dots}{A_t}$$

Where:

$$C = \text{Weighted Runoff Coefficient (dimensionless)}$$

$$A_{1,2,\dots} = \text{area of land use (ha)}$$

$$C_{1,2,\dots} = \text{runoff coefficient corresponding to land use/soil type (dimensionless)}$$

$$A_t = \text{total drainage area (ha)}$$

Note that **Table 5-3** classifies the different land uses based on Hydrologic Soil Groups. A description of each Hydrologic Soil Group is outlined below.

Hydrologic Soil Groups (Adapted from MTO Drainage Management Manual, Design Chart 1.08 [7])

Sands, Sandy Loams and Gravels

A: Overlying sand, gravel, or limestone bedrock, very well drained

AB: Same as above, imperfectly drained

B: Shallow, overlying Precambrian bedrock or clay subsoil

Medium to Course Loams

AB: Overlying sand, gravel, or limestone, well-drained

B: Shallow, overlying Precambrian bedrock or clay subsoil

Medium Textured Loams

B: Shallow, overlying limestone bedrock

BC: Overlying medium textured subsoil

Silt Loams, Some Loams

BC: With good internal drainage

C: With slow internal drainage and good external drainage

Clays, Clay Loams, Silty Clay Loams

C: With good internal drainage

CD: With imperfect to good external drainage

D: With slow internal drainage and good external drainage

Table 5-3 Runoff Coefficient – Rural [7]

Land Use		Runoff Coefficient 'C'		
		Soil Group A – AB	Soil Group B – BC	Soil Group C – D
Cultivated	Flat, 0 - 5% grade	0.22	0.35	0.55
	Rolling, 5 - 10% grade	0.30	0.45	0.60
	Hilly, 10 - 30% grade	0.40	0.65	0.70
Pasture	Flat, 0 - 5% grade	0.10	0.28	0.40
	Rolling, 5 - 10% grade	0.15	0.35	0.45
	Hilly, 10 - 30% grade	0.22	0.40	0.55
Woodlot or Cutover	Flat, 0 – 5% grade	0.08	0.25	0.35
	Rolling, 5 - 10% grade	0.12	0.30	0.42
	Hilly, 10 - 30% grade	0.18	0.35	0.52
Lawn	Flat, < 2% grade	0.05	0.11	0.17
	Average, 2 - 7% grade	0.10	0.16	0.22
	Steep, > 7% grade	0.15	0.22	0.35
Lakes and Wetlands			0.05	
Impervious Area	i.e., buildings, roads, parking lots, etc.	0.95	0.95	0.95
Gravel		0.40	0.50	0.60
Unimproved Areas		0.10	0.20	0.30

Table 5-4 Runoff Coefficients - Urban - 5-yr to 10-yr Storms [7]

Land Use		Minimum	Maximum
Business	Downtown	0.70	0.95
	Neighbourhood	0.50	0.70
	Light	0.50	0.80
	Heavy	0.60	0.90
Residential	Single Family Urban	0.30	0.50
	Multiple, detached	0.40	0.60
	Multiple, attached	0.60	0.75
	Suburban	0.25	0.40
	Apartment	0.50	0.70
Industrial	Light	0.50	0.80

	Heavy	0.60	0.90
Greenspace	Park	0.10	0.25
	Playground (unpaved)	0.20	0.35
	Cemeteries	0.10	0.25
Pavement	Asphalt of Concrete	0.80	0.95
	Brick	0.70	0.85
Gravel Road and Shoulders		0.40	0.60
Roofs		0.70	0.95
Railroad Yard		0.20	0.35
Unimproved Areas		0.10	0.30

In the event of estimating flows for the 10-yr storm and larger, the runoff coefficients are to be adjusted to account for the increased runoff caused by the soil being saturated. See the coefficient adjustment formulas below:

$$\text{25-yr} \quad C_{25} = 1.10 * C_5$$

$$\text{50-yr} \quad C_{50} = 1.20 * C_5$$

$$\text{100-yr} \quad C_{100} = 1.25 * C_5$$

*Note: Maximum adjusted coefficient of 1 is permissible

The Rainfall Intensity (i) in the Rational equation is to be determined using an Intensity-Duration-Frequency (IDF) curve information in **Table 5-5** and the equation below. The source of the IDF curve information is found in **Section 5.3**.

Table 5-5 IDF Curve Parameters

Return period	2-yr	5-yr	10-yr	25-yr	50-yr	100-yr
A	24.4	32.4	37.8	44.5	49.5	54.4
B	-0.699	-0.699	-0.699	-0.699	-0.699	-0.699

$$i = A * (T_c)^B$$

Where:

i = rainfall intensity (mm/hr)

A, B = IDF equation constants, see Table 5-5 (dimensionless)

T_c = time of concentration (minutes)

The time of concentration for upstream, undeveloped land, can be calculated using the Airport Method Formula or the Bransby-William Formula. The Airport Method is to be used when a catchment's runoff coefficient is less than 0.4 and the Bransby-William Formula when the catchment's runoff coefficient is greater than 0.4. See both methods below.

Airport Method Formula

$$T_c = \frac{3.26 * (1.1 - C) * L^{0.5}}{(S_w)^{0.33}}$$

Where:

T_c = time of concentration (minutes)

C = runoff coefficient (dimensionless)

L = catchment length (m)

S_w = catchment slope (%)

Bransby-William Formula

$$T_c = \frac{0.057 * L}{(S_w)^{0.2} * A^{0.1}}$$

Where:

T_c = time of concentration (minutes)

L = catchment length (m)

S_w = catchment slope (%)

A = catchment area (ha)

The time of concentration for upstream land that is developed, can be calculated using the following method:

1. Determine the length of the catchment in meters;
2. The T_c for the first 50 m shall be 10 minutes;
3. The T_c for the residual length shall be calculated by multiplying the residual length by 2 m/s^[1];
4. The sum of Step 2 and Step 3 shall be the final T_c value in minutes.

^[1] If the catchment has an adequate storm sewer system (sewers, channels, culverts etc. the velocity may be greater than 2 m/s)

The minimum initial time of concentration shall be 10 minutes.

5.4.2 Pipe Capacity

The hydraulic capacity of the storm sewer can be calculated using Manning's formula (for pipes flowing full). See Manning's equation below:

$$Q = 1/n * A * R^{2/3} * S^{1/2}$$

Where:

Q = capacity of the pipe (m^3/s)

n = manning's roughness coefficient (dimensionless)

A = flow area (m^2)

$R = A/P$ = hydraulic radius (m)

P = wetted perimeter (m)

S = slope of the pipe (m/m)

Standard values for Manning's roughness coefficient (n) used in the above formula can be found in **Table 5-6** below.

Table 5-6 Manning's Roughness Coefficients

Pipe Material	Roughness Coefficient 'n' (dimensionless)
Concrete	0.013
PVC	0.013
Corrugated Pipe (culvert use only)	0.024
Corrugated HDPE	0.024
Smooth Walled HDPE	0.013

Storm sewer pipes shall be designed such that they flow at a maximum of 80% of their full flow capacity. The Town must be consulted and approve any pipe designed to flow greater than 80% full.

5.4.3 Pipe Size

The minimum storm sewer diameter shall be 300 mm for a residential mainline and 375 mm for industrial and commercial areas. The diameter of downstream pipes shall be greater than or equal to the upstream pipe, unless otherwise approved by the Town.

5.4.4 Pipe Velocities

The acceptable range of flows within a stormwater pipe is as follows:

Minimum Flow: 0.6 m/s

Maximum Flow: 6.0 m/s

Storm flows exceeding the maximum stated above are subject to Town approval.

5.4.5 Pipe Slopes

The slope of the storm sewer pipe slope shall be calculated such that the minimum and maximum velocities are maintained for the respective size of the pipe.

5.4.6 Sewer Layout

The location of the Storm Sewer in the road right-of-way is generally to conform to the Standard Road Cross-Sections provided in **Appendix C**. Where possible, Storm Sewer Maintenance holes should be placed outside of the wheel track lanes. In the event that a Storm sewer is located in an easement, the easement shall follow the widths in **Table 5-7** wide, unless otherwise approved by the Town.

Table 5-7 Storm Sewer Minimum Easement Width

Pipe Size (mm)	Maximum Depth of Invert (m)	Minimum Width of Easement (m)
250 – 375	3.0	4.0
450 – 675	3.0	4.5
750 – 1500	3.0	6.0
1650 & Greater	4.0	4.0 plus 3 times O.D. of Pipe

5.4.7 Pipe Clearance

The clearance between the Storm Sewer and Sanitary Sewers or Watermains must conform to the MECF guidelines [1] or alternatively, the MECF Procedure F-6-1 [4].

Storm sewers that run parallel to sanitary sewers or other storm sewers must maintain a horizontal distance of 0.8 m between the outside of their barrels. Storm sewers that run parallel to watermains must maintain a horizontal distance of 2.5 m of clear separation (outside barrel to outside barrel) between them. For both sanitary sewers and watermains, in locations where this is not possible to maintain 2.5 m of clear horizontal separation, the pipes can be oriented vertically if the crown of the sewer is 0.5 m below the invert of the watermain. The space between the two pipes must be filled with in situ material or compacted backfill to prevent excessive joint deflection and settling. Joints should be offset as much as possible between sewers and watermains.

For storm sewer/watermain crossings, if it is not possible to achieve the vertical separation distances outlined above, one of the following methods may be used.

- The storm sewer should be designed and constructed to the specification of the watermain and be pressure tested at 350 kPa (50 psi) to assure water tightness; and/or
- Either the storm sewer or the watermain should be encased in a watertight carrier pipe which extends 3.0 m on both sides of the crossing, measured perpendicular to the watermain.

5.4.8 Bedding and Backfill

The storm sewers shall be installed with bedding and backfill that is completed in accordance with OPSD 802.010 to 802.014 for flexible pipe or 802.030 to 802.034 for rigid pipe as applicable. Well-graded Granular 'A' to OPSS. MUNI 1010 or an equivalent that is approved by the Geotechnical Engineer and the Town is to be used for the storm sewer bedding and backfill to the spring line. Compaction is to be a minimum of 95% SPMDD or as indicated in the approved Geotechnical Report.

In the event of soft or wet conditions, alternative bedding and backfill measures may be required based upon additional Geotechnical investigation.

5.4.9 Depth of Cover

The minimum depth of cover over a storm sewer pipe is to be the greater of the following options:

1. 1.5 m from the spring line of the sewer to the centerline of the road or finished ground surface elevation; or
2. 1.2 m to the obvert of the storm sewer (as long as there are no conflicting utility crossings); or
3. The minimum depth required to allow for a sump pump to drain below finished grade at the building and falling at a 1.0% slope to the storm sewer.

If it is not possible to achieve the minimum cover necessary, the Town may approve the use of insulation to allow for a shallower storm sewer installation.

The maximum depth of cover is not to exceed that which is laid out in OPSD 805.010 through OPSD 807.050 as applicable to the specified pipe material. The Town may accept a higher depth of cover if pipe strength design calculations are presented and deemed acceptable.

5.4.10 Maintenance Holes

Maintenance Holes are to be pre-cast per OPSD 701.010 to OPSD 701.081 as applicable to the specified structure diameter as well as the most recent applicable OPSS and OPSD. In the event that a maintenance hole does not conform to the standard drawings, maintenance hole shop drawings and details are to be provided for approval by the Town. Any curved or deflected storm sewer sections will require approval from the Town.

5.4.10.1 Maintenance Hole Size

Storm sewer Maintenance Holes shall be precast units with a minimum size of 1,200 mm diameter, unless otherwise approved by the Town.

5.4.10.2 Location and Spacing

Storm Sewer Maintenance Holes are to be located within the road Right-of-Way in accordance with the Town's standard Road Cross Section Design Drawings.

Storm sewer maintenance Holes shall be located at each of the following occurrences:

- Beginning of each storm sewer line;
- End of each storm sewer line;
- Change in storm sewer pipe size;
- Change in storm sewer material size; and
- Change in grade or alignment.

The maximum spacing between Storm Sewer Maintenance Holes is provided in **Table 5-8**.

Table 5-8 Storm Sewer Maintenance Hole Spacing

Storm Sewer Pipe Diameter	Maximum Spacing Between Maintenance Holes
300 mm to 600 mm	120 m
650 mm or greater	150 m

5.4.10.3 Direction Change and Drops

Storm sewer pipes that are 825 mm in diameter and smaller shall have a maximum change in direction of 90°. For storm sewer pipes that are 900 mm in diameter and larger, the maximum change in direction will be 45°.

All storm sewer maintenance holes shall have a drop between the inlet and the outlet pipe invert to compensate for the hydraulic losses going through the structure. The minimum drops across a storm sewer maintenance hole are provided in **Table 5-9**. The change in direction of the flow through a Storm Sewer Maintenance Hole must be 90° or less.

Table 5-9 Storm Sewer Maintenance Hole Minimum Drop

Change in Direction	Minimum Drop
Straight through (0°)	0.03 m
1° – 45°	0.05 m
45° – 90°	0.08 m

In the event that a drop of 0.9 m or greater is required, an external “tee” (OPSD 1003.010) or “wye” (OPSD 1003.020) drop structure is required. No Internal Drop Structures will be permitted.

5.4.10.4 Sumps

All storm structures are to have 300 mm or greater sump depth.

The obvert of the inlet pipes shall not be lower than the obverts of the outlet pipes, unless approved by the Town.

5.4.10.5 Safety Platform

Safety platforms shall be installed per OPSD 404.020 for structures that have greater than 5.0 m from the top of the grate to the bottom of the structure.

5.4.10.6 Frost Straps

Frost Straps are to be installed on all maintenance holes per OPSD 701.100.

5.4.10.7 Lids, Rims, and Covers

Storm sewer maintenance holes that are within the travelled part of the roadway shall be fitted with a rim that is set to be flush with the base course asphalt and/or top course asphalt. A maximum of 300 mm vertical adjustment using a minimum of one (1) and a maximum of three (3) adjustment units to raise the frames to the final grade. Pre-cast concrete riser sections are to be used if the adjustment height exceeds 300 mm.

Storm sewer maintenance holes frame and grate to OPSD 401.010 with a Type B open cover stamped "STORM" and the date of installation, unless it is located in an area that is designed to surcharge during larger storm events. For areas that will surcharge due to a high hydraulic grade line, a bolted maintenance hole cover to OPSD 401.060 shall be used. For areas that could be flooded during major storm events and are not bolted, a watertight maintenance hole cover to OPSD 401.030 is to be used.

Maintenance holes rims and lids are to be installed according to applicable OPSS and OPSD and complete with Autostable covers and Polyethylene Moduloc per OPSD 704.011. For top course asphalt, Ductile Iron – Manhole risers are to be used.

5.4.11 Catchbasins

Storm sewer catchbasins are to be pre-cast and designed according to the most recent applicable OPSS and OPSD. Single inlet catchbasin shall be to OPSD 705.010 and twin inlet catchbasin shall be to OPSD 705.020. Catchbasins are to be located out of the roadway with Raised Curb inlet Frame and Cover per OPSD 400.081.

5.4.11.1 Location and Spacing

The location of catchbasins will be determined during the design stage and shall be intentionally placed to collect surface storm water and convey it through to the underground stormwater conveyance network. Catchbasins are to be located per the Standard Road Cross Sections identified in **Appendix B**.

Catchbasins should typically be located upstream of sidewalk crossings at intersections and upstream of all pedestrian crossings. They should not be located in the curb depression for driveways or sidewalks. To ensure adequate drainage, additional catchbasins may be required at road intersections, elbows, curves, and cul-de-sacs.

Double inlet catchbasins shall be used if flows are being directed to the catchbasin location from more than one direction (i.e. at all low points).

The maximum allowable spacing for catchbasins is present in **Table 5-10**.

Table 5-10 Catchbasin Maximum Spacing

Pavement Width	Maximum Spacing	
	Slope \leq 4.5%	Slope $>$ 4.5%
8.5 m	90 m	60 m
12.0 m	70 m	50 m
14.0 m	60 m	40 m

Where catchbasins are used as inlet controls, spacing shall be determined by design and must be approved by the Town.

5.4.11.2 Capacity

Catchbasin capacity and spacing shall be designed such that the design flow for the sewer is not restricted from entering the sewer system at any given inlet location. On roadways, catchbasins shall have a minimum capacity to pass the runoff from the 1:5-year return frequency storm. Where the pipe system is required to convey flows in excess of the 1:5-year return frequency storm, sufficient catchbasin capacity shall be provided to permit the design flows to enter the sewer system. Inlet control devices may be used where the hydraulic grade line needs to be strictly controlled to prevent surcharging of the sewer line and to allow storm sewer house connections.

5.4.11.3 Catchbasin Lead

Catchbasin leads shall be connected to maintenance holes when they are in close proximity. If a catchbasin lead is more than 20 m long, it must be connected to a maintenance hole, unless otherwise approved by the Town. The maximum length of a catchbasin lead shall be 30 m. The depth of cover for catchbasin leads shall be at least 1.2 m to the obvert of the pipe. The minimum diameter of a lead shall be 250 mm at 0.7% for a single inlet catchbasin and 300 mm at 0.7% for a twin inlet catchbasin.

5.4.11.4 Rear Lot Catchbasins

Rear Lot Catch Basins (RLCBs) may be used to drain and convey stormwater from the rear lots. RLCBs are to be designed in accordance with the drainage areas shown on the storm drainage plan and included in the storm sewer design sheet. Where rear lot catchbasins are implemented, an emergency flow route must be implemented in the grading design that limits ponding to 0.3 m maximum. RLCBs are to be sumpless, with the lead and structure located on the same lot (i.e. not on the property line) with an easement for access. The entire lead length is to be encased in concrete or unless a concrete pipe is specified. The minimum diameter and slope of the lead are 250 mm at a 0.5% slope. RLCB leads are to connect to maintenance holes, catchbasins or catchbasin maintenance holes wherever possible. If connected to a catchbasin, the catchbasin lead to the main line sewer must be sized appropriately for its tributary drainage area. If it is not possible, the lead may be connected to the storm sewer directly, upon approval from the Town.

In the event that a RLCB is located on private property, an easement owned by the Town will be required. The easement is to be maintained by the property owner. No permanent structures are allowed in the easement.

5.4.11.5 Lid, Rim and Covers

Catchbasin frame and grate to be OPSD 400.081 for structures located in the roadway. Rear lot catchbasins shall have a birdcage frame and grate to OPSD 400.120. A minimum of one and a maximum of three adjustment risers are permitted to be installed on top of a catchbasin. A maximum of 300 mm vertical adjustment using modular rings is permitted to raise the frames to the final grade. Pre-cast concrete riser sections are to be used if the adjustment height exceeds 300 mm.

5.4.12 Storm Service Connections

5.4.12.1 Residential

Residential storm sewer connections are to be constructed in accordance with OPSD 1006.010. Single residential storm connections are to be a minimum of 125 mm in diameter at a minimum 2.0% grade. Double "Y" residential storm connections may be used for townhouses or semi-detached houses and are to be a minimum of 150 mm diameter at a minimum 2.0% grade. A 100 mm x 100 mm test fitting that is plugged, braced, and marked at the property line is required for both types of connections.

The minimum depth of cover shall be 1.5 m or the depth required for frost protection. If it is not possible, a sump pump can be used, see the sump pump detail in **Appendix C**. Special consideration must be taken during the design stage to ensure there are no conflicts with other utility mainlines or services. Storm service connections are to pass under the watermain whenever possible.

In the event that a sump pump discharges to a storm service, no direct connection shall be made between the sump pump outlet and the storm drain. An air gap of a minimum of 25 mm is required.

5.4.12.2 Industrial/Commercial/Institutional

The storm sewers for Industrial, Commercial, and Institutional lots shall be designed on an individual basis and approved by the Town.

In general, the service connections for Industrial, Commercial, and Institutional properties require a minimum pipe diameter of 200 mm and a preferable minimum grade of 2.0% and an absolute minimum grade of 1.0%.

5.4.13 Roof Leaders

Roof leaders are not to be connected to the storm drain. Roof leaders shall drain to a splash block at ground level. The flow shall be directed away from the building to keep water from the foundation weeping tile.

5.4.14 Foundation Drains

The underside of the basement footing (USF) shall be 0.5 m above the seasonal average groundwater table to reduce the storm flow rate that is contributed by foundation drains. For Subdivision Applications, the groundwater elevation shall be monitored for a minimum of one (1) year.

5.4.15 Testing

5.4.15.1 Deflection Testing

Polyethylene and PVC storm sewers shall be deflection tested in accordance with OPSS.MUNI 410.

5.4.15.2 Flush and CCTV Inspection

All new storm sewers including the mainline, maintenance holes, catchbasins and leads, and rear lot catchbasins and leads, shall be flushed, and undergo a CCTV inspection in accordance with OPSS.MUNI 411 and OPSS.MUNI 409, at substantial completion and prior to assumption. A digital copy of the CCTV videos shall be provided to the Town for review and approval along with a review tracking chart and deficiency list. Upon review, if the Town deems any section of the storm sewer unacceptable, it shall be repaired/replaced to the satisfaction of the Town and be CCTV inspected again to confirm the repair.

5.4.15.3 Visual Inspection

All maintenance holes shall be visually inspected by the Town or a representative appointed by the Town.

5.4.16 Materials

Trunk Storm Sewer shall be PVC DR 35 and Storm Service Laterals PVC DR 28, or approved equivalent.

5.5 MAJOR STORMWATER MANAGEMENT SYSTEM

5.5.1 General

The major drainage system is to be designed to safely convey the design flows that are in excess of the minor system. The major system is made up of a series of roadways, swales, walkways, and culverts that direct stormwater to an appropriate outlet.

The combination of the major system and the minor system shall be designed to prevent flooding on private property and maintain acceptable flow depths on roads and walkways during the Regulatory Event. The Regulatory Event is the storm that creates the larger peak flow between the unrouted 100-yr storm and the Hurricane Hazel storm.

For new subdivisions, unless protected by drainage easements, overland flow flood lines for the 100-yr or Hazel storm event shall not be on private property. Development of any land shall not increase flood levels upstream or downstream of the development.

5.5.2 Stormwater Modelling

A Town approved hydrologic model shall be used to determine pre-development peak flows. The model inputs to define the watershed definition must be approved by the Town.

The Rational Method can be used to determine preliminary estimates of post-development flow rates.

The most recent version of the computer model Visual OTTHYMO is recommended for modelling all systems, designing surcharged sewers, and designing detention facilities. The Town may accept other hydrograph methods if it can be confirmed that the results are similar to those from OTTHYMO.

The Rational Method can be used for determining post-development design flows only if the design area is less than 35.0 ha and runoff control facilities are not considered. The Modified Rational Method may be used to model runoff routed at a stormwater management facility only if the tributary area to the facility is 5.0 ha or less.

5.5.3 Over-Land Flow

Overland flow should not be routed into the forebay of a SWM pond to prevent re-suspension of sediment. In the event that there is no reasonable alternative, the Town may accept overland flows into a forebay.

5.5.4 Approvals

In the case where the stormwater flow is directed over private land, the developer must obtain a legal right of discharge registered on file. The design submission must include copies of all written documentation such as a legal right of discharge registered on title and/or written permissions from the Town.

5.5.5 Roads

The overland flow that results from the 1:100-year storm event shall be conveyed within the public road allowance. The flow over a road or path to get to an appropriate outlet shall not exceed a depth of 0.30 m (measured at the gutter) and the product of the depth of flow at the gutter (m) and the flow velocity shall be mitigated where possible.

5.5.6 Culverts/Bridges

Culverts and bridges must be designed to convey the storm flows from overtopping various road types per **Table 5-11**. The Town may request protection from the Regulatory Event for some locations.

Table 5-11 Storm Culvert and Bridge Storm Protection

Road Type	Storm Event to be Protected Against
Major (Arterial Roads)	100-yr storm
Minor (Urban Local Roads)	50-yr storm
Minor (Rural Local Roads)	25-yr storm
Temporary Detour	10-yr storm
Driveways	10-yr storm

Bridges and culverts also need to be designed such that watercourses do not experience an increase in flows during the Regulatory Event. All culverts and bridges require headwall protection that is in line with current OPSDs and to the Town's satisfaction.

All culverts, bridges and other drainage structures shall be designed and constructed following the most updated drawings and specifications from the following agencies; the Town, MECP, MTO, MNRF, DFO, etc.

5.5.7 Channels

Overland flow channels are to be designed to convey the peak flows from the 1:100-yr storm event without flooding adjacent private properties.

The minimum channel grade is 0.5% and the maximum is 5.0%. Channel slopes less than 2.0% required a perforated underdrain placed in clear stone. In the event that the channel is within the road allowance, a grade higher than 5.0% may be allowed, subject to Town approval. The Town may also require that an urban cross-section be applied for that road segments with ditches that have grades higher than 5.0 %. If a grade higher than 5.0% is accepted, erosion protection to the satisfaction of the Town will be required. The minimum erosion protection for channels of all grades is 300 mm of topsoil and staked sod on the side slopes and channel bottom.

All channels and other drainage paths shall be designed and constructed following the most updated drawings and specifications from the following agencies; the Town, MECP, MTO, MNRF, DFO, etc.

5.5.8 Ditches

In rural areas, estate residential subdivisions and industrial areas, open ditches may be allowed, subject to Town approval. Ditches shall be constructed a maximum of 0.5 m and a minimum of 0.15 m below the sub-grade of the roadway, shall drain to an appropriate outlet and have the appropriate erosion control measures incorporated into the design. The minimum erosion protection for ditches is 100 mm of topsoil and staked sod on the side slopes and channel bottom. If the velocities in the channel are expected to exceed 1.5 m/s during the 1:5-yr storm or 2.5 m/s for the 1:100-yr storm, more robust erosion control measures will need to be proposed and approved by the Town.

5.5.9 Watercourses

Watercourses and their flood plains shall be capable of handling the Regulatory flood event. Existing watercourses are to be left in their natural states as much as possible.

The design for natural channel design shall be in line with the design principles laid out in the Adaptive Management of Stream Corridors in Ontario (MNR, 2002). A natural channel shall be designed to have baseflow, and be able to convey the 1:2-yr storm. The adjacent floodplains should follow the natural channel principles. The channel shall be designed to convey the runoff from the Regulatory flood event. The channel shall be vegetated to the Town's approval. The side slope shall not exceed 4:1 (H: V).

5.5.10 Appropriate Outlets

The stormwater generated from all new development areas must be directed to a sufficient outlet. A sufficient outlet is typically defined as a lake, a permanently flowing watercourse, or a Stormwater

Management Facility. In the event that written permission is granted by the Town, a sufficient outlet may also include the public right-of-way.

5.6 MAINTENANCE

To ensure the major conveyance system is working at its optimal level for the length of the projected life span, regular maintenance is required. The main elements of an effective maintenance program include:

- Regular street sweeping and cleaning of catchbasins;
- Regular inspection and repair of storm sewer conveyance infrastructure;
- Regular inspection and repair of overland conveyance components;
- Regular inspection and repair of total capture inlet grates and removal of debris; and
- Regular inspection and repair of the storm drainage system.

The developer shall maintain all stormwater infrastructure and systems, including routing cleaning, until the end of the maintenance period and the Town assumes the subdivision.

6 STORMWATER MANAGEMENT FACILITIES

6.1 GENERAL

New development has a high potential to negatively impact the hydrologic cycle; increased impervious area results in greater runoff and pollutant transport off-site. Measures may be taken to mitigate the impact of development on the hydrologic cycle by implementing stormwater quality and quantity controls. Typical quality and quantity control measures used in Ontario are broken down into two (2) categories; low impact developments (LID)s which include lot level/ source controls and conveyance controls and end of pipe controls which include wet ponds, dry ponds, wetlands, and hybrid wet pond/ wetlands. Henceforth end of pipe controls shall be referred to as stormwater management facilities (SWMF)s as a catch-all term referring to the 4 types listed above. LIDs and SWMFs can provide water quantity control by storing runoff and releasing it to an outlet at controlled rates. They can also provide water quality protection by removing pollutants through sedimentation and filtration of runoff. SWMFs and LIDs can also enhance groundwater recharge and infiltration by capturing runoff and retaining it so that it has enough time to infiltrate into the ground.

The Town has outlined specific design requirements for the construction of municipal and private services related to stormwater management facilities. However, it's the developer's responsibility to submit a completed Stormwater Management (SWM) Plan Package which demonstrates competent engineering design in full compliance with all applicable regulations and legislation. These design requirements outlined in this section are general in nature and do not absolve the developer/engineer of their responsibility.

The Town requires a detailed engineering review of the proposed Stormwater Management (SWM) Plan at both the conceptual/preliminary design and the detailed design stages, which must be submitted in the form of a Preliminary SWM Report or a Final SWM Report, depending on the design stage.

For site plan developments a Final Stormwater Management Plan is required with the initial submission.

6.2 STORMWATER QUANTITY AND QUALITY CRITERIA

6.2.1 Water Quantity Control Criteria

The stormwater management plan must demonstrate that proposed condition peak flows to all site outlets are controlled to existing condition levels for the 1:2-year through 1:100-year 4hr Chicago and 24hr SCS Type II Design Storms. Where there are uncontrolled drainage catchments draining to an outlet, overcontrol of a controlled catchment draining to the same outlet is required to match total peak flows to the outlet.

6.2.2 Supporting Calculations and Hydrologic Modelling

Typically, the Town requires that proposed SWMFs and LIDs being used for quantity control are included in a hydrologic model created in Visual OTTHYMO or PCSWMM. Should a different model be used, the

proponent may be asked to re-submit their analysis using software in use by the Town. The Town will also accept the use of the Modified Rational Method, for development sites that are less than 5 ha. At the discretion and approval of the Town, quantity control of stormwater flows may not be required if the development site fronts Georgian Bay with a clear outlet path.

6.2.3 Water Quality Control Criteria

The stormwater management plan must demonstrate water quality protection to enhanced level 1 MOE levels corresponding to 80% TSS removal. Uncontrolled drainage must be compensated for by overcontrol of treated drainage.

6.2.4 Water Balance

Where native soil conditions are conducive to infiltration, infiltration practices should be implemented to maintain existing condition infiltration volumes. The *MECP "Low Impact Development Stormwater Management Guidance Manual"* [8] can be used to as a reference.

6.3 STORMWATER MANAGEMENT FACILITIES

All stormwater management facilities are to be designed in accordance with the most current MECP *"Stormwater Management Planning and Design Manual"* [9]. Where feasible, the "preferred" design criteria should be implemented. The information in the next sections is intended to supplement the design criteria and requirements presented in the MECP manual, as amended from time to time.

6.3.1 SWMF Types

6.3.1.1 Dry Pond with Extended Detention

Dry ponds shall generally service drainage areas that are smaller than 5.0 ha. In the event that a dry pond is required for a larger drainage area, Low Impact Development components must be integrated into the design to infiltrate the runoff from the 25 mm storm event. Dry ponds for smaller developments may be used as a part of a treatment train approach, provided that an enhanced level of water quality treatment is achieved.

MECP SWMPDM can be consulted for design details.

6.3.1.2 Wet Pond with Extended Detention

Wet ponds are the preferred end-of-pipe control facility for drainage areas that are greater than 5.0 ha. Wet ponds shall be designed in accordance with the guidelines of the MECP SWMPDM.

6.3.1.3 Wetland with Extended Detention

The Town will accept a wetland as a stand-alone end-of-pipe control facility. Wetlands shall be designed in accordance with the guidelines in the MECP SWMPDM.

6.3.1.4 Hybrid Wet Pond / Wetland with Extended Detention

The Town will accept a wet pond/wetland hybrid as a stand-alone end-of-pipe control facility. Hybrid wet ponds / constructed wetlands shall be designed in accordance with the guidelines in the MECP SWMPDM.

6.3.1.5 Infiltration Basin

The Town will typically not accept an infiltration basin as a stand-alone end-of-pipe facility, unless as part of a treatment train approach or as an additional feature. Infiltration basins shall not be permitted for drainage areas > 5.0 ha.

See the MECP SWMPDM for design details.

6.3.2 SWMF Water Depths

The following water depths will be permitted in the End of Pipe facilities:

Table 6-1 SWMF Water Depths

	Wet Pond	Wetland	Dry Pond
Maximum Permanent Pool Depth	2.5 m	-	-
Average Permanent Pool Depth	1.0 m - 2.0 m	150 to 300 mm, 1.0 m at inlet and outlet	-
Extended Detention (Active Storage)	2.0 m	1.0 m for storms < 10-yr	-
Quality and Erosion Control	1.0 m	-	-
Maximum Overall Depth	3.0 m	3.0 m	2.0 m
Forebay Minimum Depth	1.5 m	1.0 m	1.5 m

6.3.3 Sediment Forebay

Forebays, and all design aspects related to the forebay (i.e., bottom width, berm, dispersion length) shall be designed according to the guidelines outlined in the Stormwater Management Planning and Design Manual [9].

The berm separating the forebay from the main cell shall be constructed with a forebay weir invert at the normal water level (NWL) and lined with appropriate erosion protection. The berm and forebay weir shall be designed to pass the water quality event (25 mm event) without overtopping any other part of the forebay berm. The minimum depth of the forebay shall be 1.0 m, and the minimum top width of the berm shall be 1.0 m with side slopes of 3:1. Forebays are to be designed with a minimum sediment storage volume to allow 10 years of sediment accumulation in the forebay while maintaining 75% TSS removal efficiency for water quality.

The Forebay shall be hydraulically connected to the main cell via culverts such that the forebay is able to drain to the main cell during the pumping of the SWM pond.

Forebays shall have vehicle access provided in accordance with **Section 1.3.7** to allow for the removal of sediment as required.

6.3.4 Sediment Removal and Drying Area

Sediment removed from the forebay in the SWM facilities must be dried on-site within a designated sediment drying area before being transported to the disposal area. The design must include an area within the pond where sediment drying can occur. Alternatively, if no space permits, the design may specify sediment to be removed through the use of a dewatering agent with notes and details on the drawings and within the SWM report identifying the process.

The sediment that is removed shall be disposed of in an approved off-site location in accordance with OPSS.MUNI 180 and O. Reg 406/19 as amended from time to time. The grade and vegetation should be left undisturbed during sediment removal. If this is not possible, the grade and vegetation are to be reinstated.

6.3.5 Inlet Structures

Inlet structures shall be limited to one (1), unless otherwise approved by the Town and shall flow into the sediment forebay. Inlet structures shall be installed with the invert set to the NWL or higher. SWM pond inlet elevations are to be designed such that the 1:5-year storm design sewer capacity (as per the storm sewer design sheet) is maintained and not reduced due to tailwater conditions.

All inlets shall be equipped with a headwall, barricades, and safety grating as per OPSD 804.030/OPSD 804.040, OPSD 980.101 and OPSD 804.050, respectively.

All inlets shall have suitable erosion protection and energy dissipation treatment. The sizing of rip-rap or river stone shall be based on appropriate erosive velocity calculations. Maintenance access roads shall be provided to all inlet structures.

6.3.6 Outlet Structures

6.3.6.1 *General*

All pond outflows are to be controlled through the use of a single structure outlet system. Outlet control structures are to be located in the berm/embankment for maintenance access.

There are two different types of low flow/extended detention water quality outlet structures that the MECP Stormwater Management Planning and Design Manual (SWMPDM) [9] details and are acceptable to the Town:

- A reverse sloped outlet pipe; and
- A perforated riser outlet pipe.

These outlet structures can be used in combination with the single outlet structure. Rating curves are to be developed to show the relationship between elevation, storage, and outflow.

6.3.6.2 *Reverse Sloped Pipe*

A reversed slope pipe is appropriate where the depth of the permanent pool is greater than 1.0 m. The intake pipe shall be anchored to the bottom of the pond and fitted with a sufficient grate. The reverse

sloped pipe shall outlet to a maintenance hole control structure and have a gate valve to allow the drawdown time to be modified if required. The outlet control structure can be fitted with an overflow grate for flood control detention and overflow protection.

6.3.6.3 Perforated Riser Outlet Pipe

A perforated riser outlet pipe is acceptable where the depth of the permanent pool is less than 1.0 m. The riser's perforations shall be sized as non-limiting and designed to handle at least 1.5 times the outlet pipes-controlled flow at each stage. At the bottom of the perforated riser pipe, an orifice plate with a minimum diameter of 50 mm can be installed as the low flow / extended detention water quality hydraulic control.

If the riser is located in the pond, a minimum 1200 mm dia. vertical CSP riser shall be placed around the perforated riser pipe. The CSP riser is to have pre-punched holes which are demonstrated to be non-limiting with inlet capacities exceeding the outlet pipe's flow by at least 1.5 times at all stages. The CSP riser should have a hinged lockable lid. Stone with a minimum diameter of 75 mm shall be placed around the vertical CSP to act as a filter and protect/support the CSP.

The perforated riser outlet can also be located in a maintenance chamber in the embankment/berm of the pond. This option improves the aesthetics of the SWMF outlet. A non-controlling positive or negatively sloped pipe shall drain to the maintenance chamber with the perforated riser. A maintenance access ladder shall be provided to access the chamber.

6.3.6.4 Dewatering Sump and Maintenance Drawdown

The main cell of the SWMFs shall have a dewatering sump set to a minimum of 0.3 m below the bottom of the pond elevation and a gravity maintenance drawdown pipe with a gate valve control. The low flow/extended detention pipe as well as the gravity maintenance drawdown pipe shall be located at the bottom of the dewatering sump.

6.3.6.5 Outfall to Water Feature

The outlet pipes from all maintenance control structures shall be equipped with an anti-seepage collar or as directed by a geotechnical engineer.

The location where the outlet pipe discharges to a natural receiving water feature shall be designed with adequate erosion control and energy dissipation features; a level spreader swale is recommended to dissipate the point discharge. Erosive velocity calculations shall be completed when sizing the rip-rap or river stone for erosion control at the outfall. Maintenance access roads shall be provided to all outlet structures, where feasible.

Outlet structures shall be designed to operate under free-flowing conditions and at minimum, above the 25-year return event water level in the receiving watercourse. The water surface elevation of the receiving body must be determined and verified to ensure the proper operation of the outlet structure. In cases where it is not feasible to operate the outlet structure under free-flowing conditions, appropriate submergence/backwater calculations must be completed to ensure that the outlet structure functions correctly.

6.3.7 Emergency Spillway

All SWMFs must have an emergency spillway that is able to convey the uncontrolled peak flows from the 1:100-year storm. The invert of the spillway is to be set above the 1:100-year storm control water level.

A freeboard of 0.3 m above the spillway invert or a depth sufficient to convey the uncontrolled 1:100-year peak flow plus 0.1 m, whichever is greater, shall be provided.

The emergency spillway shall be designed with measures to prevent erosion that can withstand the maximum flow velocity. The erosion protection shall be combined with a natural vegetated surface that blends in with the surrounding landscape.

The side slopes of the spillway shall not be steeper than 3:1. In the event that an access road is incorporated, it shall be no steeper than 10:1. The spillway shall not be located directly above the outlet control structure/pipe and a minimum horizontal clearance of 3.0 m shall be provided.

The elevation of the spillway shall be higher than the elevation of the receiving watercourse during the Regional Storm whenever possible.

6.3.8 Berming

The design of berms around a wetland or wet pond must include a minimum top width of two (2) meters and a 3:1 maximum side slope outside of the pond. The core of the berm should be made of engineered fill and the soil used to construct the berm must be certified by a Geotechnical Engineer to ensure the ability of the soil to withstand expected hydrostatic pressures. Only topsoil is allowed on the outer side of the berm for vegetation growth. If the berm height exceeds 2.0 meters, it must be designed by a qualified professional engineer in accordance with the Ontario Dam Safety Guidelines[10].

6.3.9 Maintenance Access

Maintenance access roads are to be designed from the municipal road allowance with access to all SWMF infrastructure / inlets, control structure(s), outlets, emergency spillways and forebay. Co-location of access roads with trails shall be implemented wherever possible. The maintenance access road shall be looped, unless otherwise approved by the Town. In situations where this is not practical, dead-end access roads shall be designed with a hammerhead turning area consisting of a minimum hammerhead width of 17.0 m and a 12.0 m centerline turning radius, however, this option is not ideal. In the event that the access road enters the forebay below the NWL, the forebay ramp shall be constructed consistent with the lining of the bottom of the forebay or as recommended by a geotechnical engineer.

The access roads shall be designed to the following specifications:

- Minimum width of 4.0 m;
- Maximum road grade of 10.0%;
- Maximum crossfall of 2.0%;
- Minimum centerline radius of 12.0 m;

- The maintenance access base shall consist of 50 mm HL4 with a minimum base of 300 mm of compacted Granular "A" (or as recommended by a geotechnical engineer) which extends 0.5 m on either side of the paved surface;
- Maintenance access roads shall be set a minimum of 300 mm above the emergency spillway invert of the pond;
- Roadway shall be set back 3.0 m from any residential property lines;

In the event that overland inlet flow routes or the emergency spillway cross the maintenance access, reinforcing measures shall be implemented to allow the access route to carry truck loading and permit bike/stroller crossing.

6.3.10 Geotechnical Review

A geotechnical engineer is required to review the detailed design, the operations procedure, and the maintenance manual for all Stormwater Management Facilities (SWMF) for the final design submission. The geotechnical engineer must provide written confirmation that the SWMF components are acceptable.

All SWMF drawings shall include the geotechnical design parameters for soil, granulars, compaction, erosion protection etc.

Temporary Erosion and Sediment Control Facilities are to be designed using the same geotechnical standards.

6.3.11 Fencing and Gates

In General, the Town shall determine at their discretion the need for installation of fencing around Stormwater management facilities (SWMF) on a case-by-case basis.

Standard Fencing shall be a 1.5 m chain link, or a Town approved equivalent. See Standard Drawings Located in **Appendix C**.

Gates with a locking system are required on all maintenance road access points. In locations where trails and maintenance access are co-located, removable bollards shall be used. See Standard Drawings Located in **Appendix C**.

6.3.12 Trails

SWM Facilities shall include pedestrian trails where public safety has been fully addressed. The feasibility of connections to adjacent neighbourhood parks, recreation areas and existing trail networks shall be explored as part of the initial SWM facility submission plans to the satisfaction of the Town.

Trails and Maintenance Access Road shall be located together where feasible.

6.3.13 Signage

Signs that conform to Town Standards shall be installed in clearly visible areas at all SWMF access points (i.e. maintenance access road and pedestrian trail access). The developer is responsible for designing, supplying, and installing the appropriate signage to the Town's satisfaction.

6.3.14 Thermal Impacts

In the event that stormwater is discharged to a watercourse that is identified as a Cold-Water Fishery, mitigation measures must be implemented in the SWM facility to minimize thermal loading to the receiving watercourse. These mitigation measures include, at a minimum:

- shoreline planting;
- shading with trees; and
- bottom draw outlet pipes from deeper pools or cooling trenches.

6.3.15 Aesthetics

Stormwater Management Facilities (SWMF) are to be aesthetically pleasing components of a community. Where possible, they should be integrated into the trail and park network of the community. Aesthetic materials (armour stone, trees etc.) are to be used wherever possible.

6.3.16 Facilities Planting Guidelines

The vegetation in Stormwater Management Facilities (SWMF) shall follow the design criteria outlined below. These criteria are in addition to the minimum standards outlined within the MOE Stormwater Management, Planning and Design Manual and planting standards for the NVCA.

Landscaped areas shall consist of native species only as per the Native Plant Species in Ontario (Riley, 1989) provided in the NVCA Pond Planting Guidelines (NVCA, April 2006).

In the event that a SWM Planning Study (i.e. Environmental Impact Study, Ministry of the Environment Special Provisions) has been completed for the area identified for a SWMF, the design criteria and recommendations in the study shall be followed, unless otherwise approved by the Town.

6.3.16.1 Landscaping

In areas where a residential lot(s) abuts a stormwater management facility, a landscaped buffer shall separate them. The buffer shall be a minimum of 6.0 m wide, with a maximum slope of 4:1. This buffer can be included within the stormwater management block.

6.3.16.2 *Planting Zones*

Table 6-2 SWM Facility Planting Strategy Zone

Zone	Depth	Plant Type
Submergent Fringe – Deep Water	0.5 m – 2.0 m	Combination of aquatic, floating, and submergent plant species. Min. 3 species (narrow and broadleaf species)
Aquatic Fringe – Shallow Water	0.3 m – 0.5 m	Combination of aquatic, floating, emergent and submergent plant species. Min. 4 species (narrow and broadleaf species)
Shoreline Fringe – Extended Detention	Permanent Pool Area – within 1.0 meter	Flood tolerant, wetland species (i.e. sedges, rushes, wildflowers, ferns, and shrubs).
Flood Fringe	2-yr to 100-yr Water Level	Moisture tolerant herbaceous and woody species. Minimum 5 species of flood-tolerant shrubs, deciduous trees, and coniferous trees.
Upland Area	Above Erosion Control	Drought tolerant herbaceous and woody species. Minimum 7 species of drought tolerant shrubs, deciduous trees, and coniferous trees. No more than 5 of the same type in a grouping. Visual screening, aesthetic appeal, wind blockage and shading. A 1.5 m buffer between plantings and SWM infrastructure and private property. Trees along private property should be structurally sound and have strong branches to prevent impact on residential properties.

6.3.16.3 *Topsoil*

Topsoil that is used in the Stormwater Management Facilities (SWMF) must meet the current OPSS.MUNI 802. Prior to the use of any topsoil, it must be tested in a laboratory to ensure the organic and nutrient content are appropriate for use in a SWMF.

The topsoil must be stabilized using a biodegradable material after it is placed. If topsoil stabilizations cannot be completed within one (1) construction year’s growing season, the topsoil should not be placed until the following spring. In this event, sediment controls must be installed to prevent erosion of stockpiled materials.

6.3.16.4 *Hydro-Seeding and ESC Blanket*

All seed mixes shall be mixed with an annual rye nurse crop (or an approved equivalent nurse crop) upon application. It should be applied at a rate of 12 kg per hectare. Upland areas are to be seeded using a seed mixture that is native to the area and applied at a rate of 20 kg per hectare. Shoreline Fringe and Flood

Fringe areas shall be seeded using an approved 'Wet Meadow' (or seasonally flooded annual/perennial seed mix) and applied at a rate of 20 kg per hectare.

The seed shall be sown immediately following the placement of the topsoil to encourage soil stabilization. Topsoil and seed should be placed when the chances of germination are the highest. Bio-degradable erosion control blankets shall be placed on the seeded areas immediately after application where needed.

The contractor will ensure 100% coverage and seed establishment within the SWMF for the duration of the warranty period.

A biodegradable ESC blanket (24-28 months) shall be installed prior to hydroseeding and anchored in accordance with the manufacturer's specifications on all side slopes 4:1 or greater.

6.3.16.5 Guarantee Period

The developer/contractor shall guarantee that all aquatics, perennials, trees, and shrubs will not die, become diseased, or be deemed unhealthy within one (1) year from the beginning of the maintenance period. In the event that one of the installed plants does not meet the criteria mentioned above, the contractor will replace and re-guarantee it for an additional two (2) years.

6.3.16.6 Monitoring and Maintenance

Vegetation monitoring plans and schedules are required with all landscape plan submissions. The plan shall include monitoring of the performance and effectiveness of interim measures (e.g. nurse crops) and monitoring of plant health during droughts.

Mulch saucers shall be placed and maintained around the base of trees to retain water. The contractor is also responsible for regular watering of trees and shrubs for the first two (2) years after planting.

The Town will require monitoring reports to be completed every September (provided to the Town no later than October 7th) from the time of the initial plant installations until the end of the guarantee period.

6.3.16.7 Alternative Landscape Treatment for Low Impact Development

Low Impact Development approach to stormwater management is an emerging and evolving technology that is encouraging. The Town will review landscape design requirements on an individual basis.

6.3.17 Operations and Maintenance and Inspection Protocol

A stand-alone Operations and Maintenance Manual is required for each Stormwater Management Facility as part of the final design.

The Toronto and Region Conservation Authority (TRCA) document entitled "*Inspection and Maintenance Guide for Stormwater Management Ponds and Constructed Wetlands*" [11] may be used as a guide for the development of the Operations and Maintenance Manual.

The following categories should be included in the Manual, if applicable:

1. Background information;
2. Stormwater management targets/objectives and design criteria;

3. SWM facility design elements and general description of operation;
4. Stormwater management design and general description of operation;
5. Inspection and maintenance procedures;
6. Monitoring program and performance evaluation;
7. Removal and disposal of sediment;
8. Pond cleanout timeline and sediment drying area;
9. Supporting calculations;
10. Drawings and Figures; and
11. Stormwater Management Pond Post–Cleanout (Final Acceptance).

The Manual shall include inspection checklists, maintenance descriptions and projected frequency, as well as recommendations for facility cleanup.

6.4 MANUFACTURED TREATMENT DEVICES

Hydrodynamic separators or oil/grit separators (OGS) and membrane filtration units are to be used for commercial/industrial areas that have a drainage area of less than 2.0 ha. The main application of OGS is hydrocarbon spill control and should be used as one of many components of a treatment plan. OGS can also be used during redevelopment projects and for infill areas that have space restrictions and SWM ponds are not practical. OGS are not to be used as a substitute for an end-of-pipe SWMF forebay.

The design must be certified by a Professional Engineer and provided to the Town. The Town also required all supporting calculations and details regarding the anticipated maintenance requirements. Water quality calculation must be supported by Canadian Environmental Technology Verification (CA ETV) testing and certification. Where used for water quality control a supporting calculation using the CA ETV particle distribution must be provided confirming the pollutant removal efficiency and that greater than 90% of total rainfall volume is treated. Additional documentation may be required on a case-by-case basis.

6.5 LOW IMPACT DEVELOPMENT

The MECP Stormwater Management Planning and Design Manual (SWMPDM) [9] and LID Stormwater Management Guidance Manual (LID SWMGM) [8] both contain design criteria for numerous Lot Level and Source Level Control methods. **Table 6-3** outlines the different control methods that are generally accepted by the Town and the section in the SWMPDM and the SWMGM that can be used for designing the feature.

Table 6-3 Lot Level and Source Level Control Methods

Control Type	MECP SWMPDM	MECP LID SWMGM	Notes
Roof Top Storage	Section 4.5.1		Requires Town Acceptance
Rainwater Harvesting		Section 1.8.1.3	
Parking Lot Storage	Section 4.5.2		Requires Town Acceptance

Control Type	MECP SWMPDM	MECP LID SWMGM	Notes
Roof Leader Discharge to Surface	Section 4.5.5 / 4.5.6	Section 1.8.1.5	
Infiltration Trench	Section 4.5.8	Section 1.8.1.6	
Bioretention Swale / Rain Garden		Section 1.8.1.7	
Enhanced Grass Swales / Dry Swale	Section 4.5.9	Section 1.8.1.10 / 1.8.1.11	On Private Property or Requires Town Acceptance
Permeable Pavement		Section 1.8.1.9	
Pervious Pipe Systems	Section 4.5.10	Section 1.8.1.12	
Vegetated Filter Strips	Section 4.5.12	Section 1.8.1.8	On Private Property
Green Roofs	Section 4.5.14	Section 1.8.1.4	Requires Town Acceptance
Tree BMPs		Section 1.8.1.13	
Soil Amendments		Section 1.8.1.14	

The Town will consider the use of Low Impact Development (LID) measures in a Stormwater Management Plan to aid in the efforts to minimize post-development runoff volumes and maintain the pre-development hydrologic conditions within new developments, a comprehensive description prepared by a qualified engineer will be required for each project to assess the applicability of incorporating LIDs in the stormwater management design and may be included in an overall SWM Report.

All Stormwater Management Plans that include LIDs in their design shall be reviewed by the Town and other review agencies on a site-by-site basis.

6.6 EROSION AND SEDIMENT CONTROL

6.6.1 General

This section outlines the minimum criteria for the design of erosion and sediment controls that are commonly used.

Additional information can be found in the following documents.

- The MECP Stormwater Management Planning and Design Manual (SWMPDM) [9];
- Toronto and Region Conservation Authority (TRCA) Erosion and Sediment Control Guideline for Urban Construction [12].

A complete ESC Plan is required for all development sites. The ESC Plan shall include the following:

- Erosion and Sediment Control (ESC) Plans (report and drawings)
- Spill Control and Response Plans

- Inspection and Maintenance of ESC
- Performance Monitoring and Reporting

At, minimum, all control measures and plans must comply with or exceed the specifications outlined in these documents and must be capable of achieving the desired performance at all times.

The Final SWM Design Submission shall include a stand-alone ESC report. The GGHCA guidelines can be used as an example. The ESC report and drawing requirements are listed in **Table 6-4**.

Table 6-4 ESC Report and Drawing Requirements [12]

ESC Report	ESC Drawing
<ul style="list-style-type: none"> • Project Description • Conditions of Existing Site, Soil and Receiving Water Bodies • Permanent Stabilization • Design Details of all interim ESC Measures • Stockpile Detail and Design • Emergency Contacts • Stamped and Signed Report. 	<ul style="list-style-type: none"> • General Items • Site Boundary and Existing Contours • Existing Vegetation • Surface Water Locations (lakes, rivers etc.) • Regional Storm Floodplain • Proposed Contours/Elevations • Existing and Proposed Drainage Systems • Limits of Disturbance • Stockpile locations and design dimensions • ESC Measures Locations and Details • Stormwater Management Systems (temporary and permanent) • Inspection and Maintenance Notes • Access Road and/or Haul Road • Construction Phasing Plan • Signed and Stamped Drawings

Erosion prevention is the required for minimizing/eliminating impact to the surrounding landscape. To minimize the exposed area of the site at any given time, topsoil stripping and ESC controls should be completed/designed using a phased approach, whenever possible. In the event that an area is expected to remain exposed for more than thirty (30) days, a vegetation cover shall be installed. The type of vegetative cover will be dependent on the type of soil, the site grading, and the time of year. The ESC measures are expected to achieve adequate performance at all times. A contingency plan shall be in place to repair, replace and upgrade the control measures as required.

6.6.2 Runoff Control

The development of a ESC control plan is necessary to assess the concentrated runoff from surrounding areas that will flow through the site. The plan should also include measures for redirecting the runoff away from disturbed areas. If this cannot be achieved, the runoff should be channeled through armored channels with silt fencing and low point protection, before being released into a treatment facility. If a

sediment control pond is not proposed for the site, sediment control fences and cut-off swales/channels or alternative control measures must be implemented along the site's down gradient boundaries.

If a sediment control pond is not part of the proposal for a site, sediment control fences and cut-off swales/channels or comparable control measures must be installed along all boundaries that slope downward from the site.

If the site is located next to an existing residential area, a cut-off swale/channel must be installed around its entire perimeter. Additionally, a 3.0-meter wide buffer strip and/or sediment control fence must be placed along the boundaries that slope downward from the site

6.6.3 Temporary Sediment Control Ponds

A temporary sediment control pond ('TSCP') shall be required for all development/construction areas that are larger than 2.0 ha. All runoff that is not controlled by an alternative ESC feature, shall be directed to a TSCP.

Temporary sediment control ponds shall be designed to meet the following criteria:

- TSCP minimum depth is 1.0 m, maximum depth is 2.5 m, and maximum side slopes is 4:1;
- The length to width ratio of the TSCP should be 4:1;
- Emergency spillway sized to convey the 1:100-year storm event from the drainage area;
- The permanent pool volume shall be a minimum of 125 m³/ha of tributary drainage area or 185 m³/ha where the length to width ratio is less than 4:1 or the drawdown time is less than 48 hours;
- The forebay minimum depth is 1.0 m, and the maximum volume is 20% of the permanent pool
- The forebay shall have a stable bottom to allow mechanical cleanout, and incorporate sediment depth indicators;
- The active storage volume shall be a minimum of 125 m³/ha of tributary drainage area;
- A perforated riser with a minimum orifice diameter of 75 mm shall be used as an outlet; and
- The draw down time shall be a minimum of 48-hours, unless otherwise approved by the Town.

6.6.4 Silt Fence

A heavy-duty silt fence (OPSD 219.131) must be placed around the base of slopes, perimeters and on the upgradient side of all sensitive areas, streams and rivers. Silt Fence should not be utilized in areas with high flow. The silt fence should follow the contours of the site and be accompanied by a vegetative buffer strip on the down-gradient side.

6.6.5 Vegetative Buffer Strip

Vegetative Buffer Strips (VBS) shall be used upstream of vegetated protected areas and downstream of silt fences. They shall consist of undisturbed soil with established vegetation that is growing, whenever possible. For undisturbed land that is being protected, a minimum of 3.0 m wide buffer is required. For

water features that are being protected, a minimum buffer width of 15.0 m is required. Additional buffer may be required if the adjacent surface water is classified as 'cold-water'.

6.6.6 Non-Vegetated Buffer Strip

Non-Vegetative Buffer Strips (NVBS) shall be used upstream of non-vegetated protected areas and downstream of silt fences. The NVBS shall consist of undisturbed soil. A second silt fence must be installed a minimum of 1.0 m from the primary silt fence. An appropriate amount of space must be provided for access to clean out trapped sediment and complete repairs to the fence. For undisturbed land that is being protected, a minimum of 2.0 m wide buffer is required. For water features that are being protected, a minimum buffer width of 15.0 m is required.

6.6.7 Sediment Trap

Sediment Traps shall be installed in channels and ditches to reduce the velocity and help prevent erosion of the ditch bed and sides. Sediment Traps should meet the criteria laid out in OPSD 219.220.

6.6.8 Construction Site Access Mats

Construction Access Mats shall be installed at all exits from the site and shall be designed and maintained to remove most of the sediment accumulated on vehicle tires. Continuous monitoring and cleaning of the mud mat shall be required.

6.6.9 Topsoil and Spoil Pile Management

Topsoil and spoil piles shall not be placed in low areas of a site or in an area where water may accumulate. The piles shall be surrounded by a row of silt fence (a double row may be required at the Towns discretion) and shall be shown on the erosion and sediment control plans with a noted volume of material and maximum height.

In the event that the volume of a pile exceeds 100 m³ of material, it shall be a minimum of 15.0 m from all roadways and channels.

Each stockpile shall not exceed 3.0 m in height and 2,500 m³ up to a cumulative maximum of 10,000 m³ on site. In the event that more than 10,000 m³ is required to be stored onsite, an ECA will be required.

In the event that a topsoil or spoil pile is to be left in place for more than sixty (60) days, a soil stabilization method shall be employed (i.e. mulch, vegetative cover, tarps etc.).

6.6.10 Drain Inlet and Catchbasin Protection

The ESC plan shall include the protection of all potentially affected storm drain inlets and catchbasins.

Filter cloth may be utilized to protect catchbasin inlets that are in areas without ponding water and away from traffic. For all other situations, catchbasin inserts made of filter cloth with or without a metal support structure must be employed.

6.6.11 Site Dewatering

Water that is removed from the site during site dewatering operations must not drain directly into the receiving water feature.

The water that is pumped from the site shall be treated by control devices per the approved dewatering plan. The effluent water must not contain particles >40 microns in size, or more than 100 mg/L of TSS

A Permit to Take Water ('PTTW') or Environmental Activity Sector Registry ('EASR') shall be in place prior to any dewatering activity, as required by O. Reg. 63/16 and the Environmental Protection Act ('EPA')

6.7 NATURAL HAZARDS

The Town is located in a jurisdiction that is not subject to conservation authority regulation. Any development that would typically be subject to conservation authority permitting must therefore be reviewed and approved by the Town. These include flood and erosion hazards as well as interference with wetlands.

6.7.1 Shoreline Flood Hazard

Where development is proposed for a property with frontage along Georgian Bay the flood elevation shall be taken as the 1:100-year lake level plus an allowance for wave uprush. The wave uprush elevation for a specific site may be quantified by a qualified Coastal Engineer or a minimum setback of 15 m can be applied. Establishing shoreline flood hazard limits shall be in accordance with the latest MNR technical guides and recommendations.

6.7.2 Shoreline Erosion Hazard

Where development is proposed for a property with frontage along Georgian Bay, proper shoreline erosion hazard setbacks must be applied. The provincial recommendation for the minimum shoreline erosion setback from a Great Lake is 30 m from the stable slope line. A Shoreline Erosion Hazard Study may be provided by a qualified Coastal or Geotechnical Engineer which can reduce the setback to the stable slope line plus the yearly recession rate times 100 where a minimum of 35 years of reliable data exists. Establishing shoreline erosion hazard limits shall be in accordance with the latest MNR technical guides and recommendations.

6.7.3 Interference With a Wetland

Generally, no development will be allowed within wetlands or their minimum setbacks which are 30 m for unevaluated and non-Provincially Significant Wetlands (PSW)s and 120 m for PSWs. Development in a wetland or setback may be considered on a case-by-case basis provided that it can be demonstrated that the proposed works will not impact flooding, erosion, or water quality.

7 ROADS

7.1 GENERAL

The requirements for designing, building, and restoring roadways and driveways in the Town of Penetanguishene are outlined in this section.

The design and construction of the roadways must meet the minimum standards set by the most up to date version of the Transportation Association of Canada (TAC).

The following section shall be considered the minimum requirements for each specified situation. During design and construction, should the specified standard not apply, best judgment shall apply in the interest of the Town.

A Road Occupancy Permit ('ROP') will be required from the Town for work related to driveways and/or any other work which requires machinery to be used within the Town Right of Way.

7.2 ROADWAY DESIGN

7.2.1 Roadway Classification

All roadways shall be classified in accordance with the Town's Official Plan, as amended from time to time and per the approved Draft Plan for development lands. During the Draft Plan approval process, a Traffic Impact Study ('TIS') shall provide the traffic volumes for the roads which will define roadway classifications.

Residential roadway classifications shall be defined as Minor Roads (local urban and local rural), and Major Roads (Arterial). Right of ways shall be a minimum of 20 m for local designation, and 30 m for major designation. Each roadway type shall be confirmed with the Town prior to the commencement of the design.

Where a development abuts an existing road, the Developer shall deed any required road widening to allow the existing road to meet the roadway classifications established in the Official Plan.

7.2.2 Geometric Road Design

The following geometric standards shall be applied:

Table 7-1 Geometric Road Design

	MINOR (LOCAL URBAN)	MINOR (LOCAL RURAL)	MAJOR (ARTERIAL)
Min. Design Speed (km/hr)	50	60	80
Pavement Width (m)	8.5	7.0	14.0
Min./Max. Grade	0.5/6.0	0.5/5.0	0.5/5.0
Min. C/L Radii (Horizontal Curve (m))	90	130	250
Min. K Value – Sag (*Intersection)	12 (4)	18 (8)	30 (15)
Min. K Value - Crest	8	15	35
Min. Stopping Sight Distance (m)	65	85	135
Max. The grade for Through Roads at Intersections	3.5%	3%	2%

*When intersections are illuminated and provided with stop control Min. K Values can be reduced as reflected in Table.

7.2.3 Vertical Curves

For local roads, all changes in grade 2.0% or more shall be accommodated by the use of a vertical curve. For all other road classifications, all changes in grade 1.0% or more shall be accommodated by the use of a vertical curve.

7.2.4 Crossfall

All roads shall be finished with a minimum 2.0% crossfall.

7.3 INTERSECTION DESIGN

7.3.1 Geometric Intersection Design

The curb-return radii, measured from the edge of the pavement and daylighting requirements for all intersections shall be in accordance with the table below:

Table 7-2 Geometric Intersection Design

ROAD CLASSIFICATION	INTERSECTION ROAD CLASS	DAYLIGHTING (m)	MIN. CURB RADII (m)
Minor	Minor	3	10
	Major	15	10
Major	Minor	15	10
	Major	15	18

7.3.2 Backfall at Intersections

At all intersections, the crown of a Minor Road shall not impede or affect the crossfall or crown of the Major Road. A 1.0% to 2.0% backfall shall be provided on the Minor Road at all intersections. This backfall shall continue to the end of the curb return radii. The curb return minimum grade from the beginning of the curb return to the end of the curb return shall be 0.5%. The overland flow path for storm drainage through the intersection must be maintained.

7.3.3 Roundabouts

Roundabouts may be considered as alternatives for intersections under the approval and recommendations of the Town. The roundabout design shall follow the most current version of the Transportation Association of Canada (TAC), Canadian Roundabout Design Guide [13].

7.4 RIGHT OF WAY ELEMENT DESIGN

7.4.1 Roadside Ditches

Ditch invert elevations shall be constructed a minimum of 0.15 m below the subgrade of the roadway. Ditch foreslope and backslope shall be constructed with a maximum slope of 3.0 m horizontal to 1.0 m vertical. The minimum longitudinal grade for roadside ditches is 2.0% and the maximum is 6.0%. All ditches are to receive erosion protection of 100 mm topsoil and No. 1 nursery sod, staked for all side slopes. When longitudinal ditch grades are 4.0% to 6.0%, approved engineered erosion protection shall be applied and when greater than 6.0%, storm sewers shall be installed. Refer to the Town of Penetanguishene Standard Rural Residential Road Section in **Appendix C**, for additional details.

7.4.2 Culverts

Entrance culverts shall be a minimum of 400 mm dia. and constructed with 320 kPa PVC, HDPE or equivalent. All road crossing culverts are to be a minimum of 600 mm dia. and constructed with 320 kPa PVC, HDPE, or equivalent material. Notwithstanding the specifications of minimum sizes, culvert sizes are to be designed to convey the return event per **Table 5-11** in **Section 5.5.6**.

All culverts placed within the Frost Depth shall have Frost Tapers per OPSD 803.030 and OPSD 803.031.

All joints shall be wrapped with geotextile fabric and be free of any leaks.

Culverts may be tapered to the slope per OPSD 801.010 and OPSD 801.030 for increased inlet efficiencies.

The minimum length of the culvert shall be that which is required to extend from the centre of the ditch to the centre of the ditch with matching slopes not exceeding 3:1.

Headwalls and end treatments will only be permitted where a 3:1 slope cannot be achieved. The Town will approve the designs on a case-by-case basis.

The minimum depth of cover for all culverts is 300 mm unless indicated by Town and manufacturer specifications.

7.4.3 Curbs and Gutters

For Major and Minor Roads, standard barrier curb per OPSD 600.040 (single stage) or 600.070 (two stage) is permitted. Construction of the second stage curb shall only be permitted upon inspection and acceptance of the first stage and asphalt by the Town. Temporary Asphalt Curbs and concrete mountable curbs may be permitted by the Town upon written application.

Curb cuts in residential areas shall be in accordance with OPSD 351.010. Curb cuts in commercial and industrial areas shall be in accordance with OPSD 350.010.

All concrete works are to conform to OPSS 353.

7.4.4 Subdrains

Continuous 150 mm diameter perforated subdrain wrapped in filter fabric shall be provided for all roads below the concrete curb (both sides) and installation shall conform to OPSS 405. The subdrain shall be connected to catchbasins or other suitable outlets and plugged with a manufacturer plug at high points. Subdrains shall be in accordance with OPSD 216.021. Subdrain shall be CCTV inspected per OPSS 405 with results provided to the Town.

7.4.5 Sidewalks

All sidewalks are to be per OPSS.MUNI 351 and OPSD 310.010 with a minimum width of of 1.5 m. Sidewalk subgrade shall be well graded and compacted to 95% Standard Proctor Density. A minimum of 150 mm of Granular 'A' bedding compacted to a minimum 95% Standard proctor Density shall be provided for all sidewalks.

All sidewalk contraction and expansion joints shall be saw-cut.

Sidewalk locations shall be per the Standard Road Cross-Sections provided in **Appendix C** and approved by Town. Sidewalks are to be minimum 200mm in depth and continuous through industrial, commercial, and institutional entrances.

All sidewalks shall have a minimum crossfall of 2.0% and a maximum crossfall in accordance with AODA. The maximum longitudinal grade shall be in conformance with AODA.

Tactile plates per OPSD 310.039 shall be installed at all road crossing locations and have a minimum total width of 1.2 m. Concrete sidewalk ramps shall be installed per OPSD 310.030, 310.031, or 310.033.

7.4.6 Cul-de-Sacs/Dead-Ends

The standard requirements for permanent and temporary cul-de-sacs are illustrated in Town Standard Drawings, and are located in **Appendix C**. It is permissible to dedicate easements to the Town rather than the right-of-way requirements to accommodate temporary cul-de-sacs.

Minimum gutter grades of 1.0% are to be maintained along the flow line of all gutters around the cul-de-sac. The designer shall provide sufficient drainage details (i.e. Gutter grades, crown grades and cross-fall grades) to ensure the cul-de-sac will be provided with proper drainage.

7.4.7 Driveways and Entrances

Driveway grades shall be a minimum of 2.0% and a maximum of 6.0%. Driveways shall match the sidewalk and boulevard grade to the road allowance limits.

The driveway widths shall conform to the Zoning By-Law. The minimum width is generally the width of the garage door, with the maximum being the width of the garage door plus 2.0 m. Non-residential entrances shall conform to OPSD 350.010.

Adjacent driveways shall be provided with a minimum 1.0 m separation on road bends and cul-de-sacs. The remainder of driveway separations shall meet the zoning requirements, specifically the side yard setback requirements. Water services/curb stops shall be located a minimum of 1.0 m from the edge of the driveway. All above-ground utility structures shall be a minimum of 1.2 m from the edge of the driveway, unless otherwise approved by the Town.

Driveway pavement structure shall be minimum 50mm HL3 Asphalt and 200mm Granular 'A'

Driveway pairing shall only be used in semi-detached and townhouse developments.

7.4.8 Boulevards

All boulevard areas, with the exception of the driveway/entrance locations, shall be fine-graded and finished with 100 mm topsoil in accordance with OPSS 802 and No. 1 Nursery Sod.

The boulevard areas from the back of the curb to the property line shall be graded to provide positive drainage towards the curb at a minimum of 2.0% and a maximum of 6.0%.

7.4.9 Bicycle Lanes and Multi-Use Trails

Bicycle lanes and multi-use trails shall be designed in accordance with the most current version of the Town's Official Plan and Cycling Strategy planning documents.

During the planning stage, discussions surrounding the requirements for bicycle lanes and multi-use trails shall take place. Before starting the engineering design, the Engineer must check with the Town to

determine the requirements, if any, for providing bicycle lanes or multi-use trails exist and include within the Traffic Impact Study.

7.5 SIGNAGE AND PAVEMENT MARKINGS

Signage and pavement markings designs shall be completed by the Engineer and approved by the Town. The designs shall follow the Ontario Traffic Manual (OTM) [14] and Highway Traffic Act [15].

7.5.1 Street Name Signs

Street name signs shall be placed at every intersection. All street name signs shall be mounted on galvanized steel U-Channel type posts, 3.6 m in length (1.2 m lower channel and 2.4 m upper channel) embedded at least 0.9 m in the ground. All signage must be installed using a breakaway system. Street sign template are available upon request.

7.5.2 Traffic Control Signs

Traffic control signs shall be supplied and installed by the developer per the approved Engineering drawings. Traffic control signs shall be in compliance with the Ontario Traffic Manual (OTM) [14] Regulatory Signs and Warning Signs. Traffic control signs shall be placed in accordance with the OTM and the Highway Traffic Act.

All traffic control signs shall be mounted on galvanized steel U-Channel type posts, 3.6 m in length (1.2 m lower channel and 2.4 m upper channel) embedded at least 0.9 m in the ground. All signage must be installed using a breakaway system.

7.5.3 Pavement Markings

Pavement markings shall conform to the Standards of the Ontario Traffic Manual [14] Book #11 (Pavement, Hazard, and Delineation Markings) at all intersections, school crossings, walkways, bike lanes and railway crossings to clearly identify the proper traffic zones, lanes and stop bars.

Local streets do not require centreline pavement markings, but stop bars are required with a minimum of 15.0 m of centreline marking.

Lane markings are to be organic, solvent-based, or water-borne traffic paint complete with glass beads. All lane marking applications for new asphalt require two applications of paint, with the second application not being applied until the first is tack free. Pavement markings are to conform to OPSS 710 & OPSS 1712.

Traffic lane symbols, stop bars and pedestrian crosswalks are to be durable pavement markings or field-reacted polymeric pavement markings in accordance with OPSS 710, OPSS 1713, and OPSS 1714.

7.6 PAVEMENT DESIGN

A Geotechnical Report prepared by a Professional Engineer shall form the basis for all pavement structure designs. The Report shall include results from the soil testing program and recommend a pavement design to support the expected traffic load.

The following tables provide the Town's minimum pavement structure requirements by road classification. Where the minimum recommended pavement design indicated in the Geotechnical Report exceeds the minimum requirements as outlined in the table below, the designer shall specify the higher strength pavement structure.

Table 7-3 Road Granular and Asphalt Depth

Road Classification	Granular B Subbase (mm Depth)	Granular A Subbase (mm Depth)	HL8 Binder Course Asphalt (mm Depth)	HL3 Surface Course Asphalt (mm Depth)
Minor	300	150	50	40
Major	350	150	90	40

Table 7-4 Driveway Granular and Asphalt Depth

Road Classification	Granular B Subbase (mm Depth)	Granular A Subbase (mm Depth)	Binder Course Asphalt (mm Depth)	Surface Course Asphalt (mm Depth)
Residential	-	200	-	50 HL3
Non-Residential / High Density Residential	300	150	50 HL4	40 HL3
Fire Route / Heavy Duty	400	150	90 HL8	40 HL3

7.7 ROADWAY CONSTRUCTION

7.7.1 General

The contractor shall construct all Municipal roadways and driveways in accordance with the latest OPSS.

During construction, a geotechnical consultant must inspect the condition of the roadway subgrade and supervise the installation of pipe bedding/embedment and the backfilling of all trenches within the road allowances and easements.

The subgrade shall be shaped to conform to the required longitudinal grade and cross-section and shall have a cross-fall of 3.0% from the centreline of the roadway to each side. All soft areas shall be excavated

and backfilled with similar available site material (or approved select subgrade material) and compacted to the required density specified on the approved drawings and/or geotechnical report. Prior to placing granular materials, the road subgrade shall be proof rolled to ensure uniform compaction and support for the pavement structure and approved by the Geotechnical Engineer and Town.

Placement of all granular material shall be in accordance with OPSS 314 and compaction shall conform to OPSS 501. For roadway base or subbase construction, lift thickness shall not exceed 150 mm. Granular material shall be compacted to 100% SPMDD, unless otherwise specified by the geotechnical consultant and or Town.

Asphalt pavement construction requirements shall conform to OPSS 310. Prior to placement of binder course asphalt, granular base and subbase construction shall be inspected and approved by the geotechnical consultant and Town.

7.7.2 Grading

All grading shall conform to OPSS.MUNI 206. All soft spots shall be removed and replaced with engineered fill and compacted in accordance with OPSS.MUNI 501, the Engineered Drawings, and the Geotechnical Recommendations.

7.7.3 Granular Materials

Granular Materials shall meet the requirements of OPSS 1010 and placement shall be per OPSS.MUNI 314.

Granular materials shall only be placed on a properly prepared subgrade that has been inspected and approved by the Geotechnical Engineer and the Town.

7.7.4 Proof Roll

Two (2) proof rolls are required as part of each road construction project. The First proof roll is required on subgrade prior to the placement of Granular 'B' and the second proof roll is required on Granular 'A' prior to the placement of base course asphalt. The Town and/or the Towns representative shall be invited to witness both proof rolls.

7.7.5 Tack Coat

All abutting edges and/or lap joints shall have a tack coat applied and cured prior to placement of new asphalt. Denso tape in conjunction with a butt joint is also acceptable. A tack coat shall be applied to base course asphalt prior to placement of top course asphalt. Tack Coat shall be in accordance with OPSS.MUNI 310.

7.7.6 Longitudinal and Transverse Joints

The contractor shall construct robust longitudinal and transverse joints per OPSS. All cold longitudinal and transverse joints shall have under-compacted material at the unconfined edge and be constructed with a straight, clean vertical face.

Longitudinal joints shall not be placed in wheel paths.

Any Joint cracking observed within the warranty period shall be deemed deficient and all costs associated with remediation including but not limited to removal and replacement shall be the responsibility of the Contractor.

Paving in Echelon is preferred where possible. A Traffic Control plan shall be submitted for review and approval two (2) weeks prior to asphalt placement.

An MTV (shuttle buggy) is required for asphalt delivery to the spreader, unless otherwise approved by the Town.

7.8 MATERIAL SPECIFICATIONS

7.8.1 Granular Materials

All granular materials used to construct, remediate, and maintain roadways within the Town shall be per OPSS.MUNI 1010.

Granular A and Granular B Type I may be quarried bedrock and RAP up to 30% by mass only.

Granular B Type II shall be quarried bedrock only.

The Contractor shall provide the Town with the source of the granular materials a minimum of two (2) weeks prior to construction. A sample of each material shall be tested for conformance with the contract and drawing specifications.

7.8.2 Hot Mix Asphalt

All HMA materials used to construct remediate and maintain roadways within the Town shall be per OPSS.MUNI 1150 and OPSS.MUNI 1151.

Asphalt Mix designs shall be submitted to the Town for review and approval two (2) weeks prior to placement of HMA.

7.8.3 Concrete

All concrete materials used to construct, remediate, and maintain any concrete work (i.e. curb, sidewalk pads, etc.) within the Town shall be per OPSS.MUNI 1350.

Concrete Mix designs shall be submitted to the Town for review and approval two (2) weeks prior to placement.

7.8.4 HMA Testing

All testing of HMA materials used to construct remediate and maintain roadways within the Town shall be per OPSS.MUNI 310.

8 LOT GRADING

Grading for individual lots shall be designed in accordance with the Major and Minor Drainage networks and efficiently use the maximum space available.

Lot and site grading is to be contained on Owners property and grading on adjacent lands shall only be permitted at the discretion of the Town and through written approval by the adjacent landowner.

8.1 DESIGN CRITERIA

8.1.1 Residential Lot Grading

- Landscaped areas shall have a minimum grade of 2% and maximum of 5%.
- Grading at building faces and foundations shall direct stormwater away from the building structure.
- No reverse slope driveways or yard grades will be permitted
- Side yard swales shall be a minimum of 2%. If 2% is not achievable, a french drain design complete with perforated pipe and clear stone trench is to be installed.
- At minimum, three quarters of each individual lot shall have area grades between 2%-5%.
- Slopes outside the above noted coverage shall have slopes not exceeding 3:1.
- Rear yard swales shall be located on lot lines where backyards abut one another.
- All swales, (side yard, rear yard, etc) shall be designed for the expected flows but in no case shall be less than 0.15m in depth and greater than 3:1 side slopes.
- No more than three (3) rear yards are to drain to a single side yard swale.
- Grade at the foundation of the house shall follow the grade of side yard swales and be a minimum of 0.15m below the top of foundation.

8.1.2 Rear Lot Catchbasins / Area Drains

- Rear Lot Catchbasins ('RLCB') and leads are to be located on one lot within a minimum 3m easement. The Catchbasin and Lead shall be located 1.0m from the nearest lot line measured to the closest part of the RLCB/Lead.
- RLCB are to be sumpless with a minimum lead size of 300mm.

8.1.3 Driveways

- Driveway Grades shall be between 2% and 6%.
- Minimum Driveway width is 3m.

8.1.4 Retaining Walls

- Retaining walls shall be designed by a Structural Engineer in accordance with the Building Code.
- Retaining walls are to accommodate drainage and no overland flow is permitted.
- All retaining walls shall have a weeping tile and clear stone for local drainage behind wall.

- Existing elevations and proposed elevations are to be noted on the plan and profile of the retaining wall drawings.

8.2 DRAWING REQUIREMENTS

8.2.1 Grading Plans

The Owner and/or Engineer shall identify the following items on the submitted Grading Plan(s):

- Grading plans shall be based off a local Geodetic Benchmark.
- Existing grades shall extend a minimum of 10m beyond the property line.
- Show all external land uses and structures (if applicable)
- Proposed grades at the front and rear of each housing envelope.
- Proposed grades of side yard swales, including direction arrows and slopes.
- RLCB grate and lead elevations (if applicable).
- Show offset of RLCB and lead from P/L (if applicable).
- General overland flow routes.
- Location of driveways
- Building Finished Floor Elevation ('FFE'), Top of Foundation Wall ('TFW') and Underside of Footing ('USF').
- Specify types of proposed housing unit (i.e. Walk-out, Standard, etc.)
- Steps, porches, patios, decks, etc.
- Location of existing (with invert elevations) or proposed services (water, san, storm, gas, etc.)

8.3 CONSTRUCTION

8.3.1 Foundation Certificate

Prior to proceeding with framing, the builder shall provide a OLS certificate identifying the as-built elevations and conformance with the approved engineering plans to the Town through the Owner. Where deviations from the approved plan exist, the consulting engineer is to provide written explanation and recommendation to remediate the deviation for Town review.

8.3.2 Lot Grading Certificate

The Consulting Engineer shall complete an inspection of the lot and confirm in writing the grading meets with the approved design of each individual house grading plan prior to placing sod. Upon the placement of sod, a final inspection shall be completed and the Consulting Engineer shall issue a Lot Grading Certificate.

8.3.3 Engineered Fill Certificate

Where houses are proposed to be placed on engineered fill, the fill shall be placed under the full time supervision of a qualified Geotechnical Engineer. The Geotechnical Engineer shall inspect the foundation soil for each individual lot on proposed to be placed on engineered fill. The Geotechnical Engineer shall provide written certification of the fill placement, stability and statement of each lot inspected.

9 TRAFFIC CONTROL AND TRAFFIC SIGNALS

9.1 GENERAL

The Developer is responsible for the installation of Traffic Control Devices, Traffic Signs, Street Name Signs and Pavement Markings.

A Traffic Management Plan is required as part of the Engineering Drawing Set and must be approved by the Town.

9.2 STANDARDS

Traffic control and advisory signs shall conform to the regulations laid out in the Ministry of Transportation's (MTO) "Ontario Traffic Manual" [14] or the "Highway Traffic Act Regulations for Ontario" [15].

The design of traffic signals must conform to the guidelines outlined in the MTO Ontario Traffic Manual Book 12 [14] and relevant MTO and electrical design codes. All work must be done in accordance with the current Ontario Electrical Code. Work must also abide by federal, provincial, and local laws and regulations, as well as the latest CSA Standards. The Electrical Safety Authority is required to inspect all electrical work, and in case of conflicting regulations, the most stringent rule will apply.

The design of signalized intersections must not only accommodate vehicular traffic, but also include provisions for pedestrians and accessibility features. All pedestrian crossings must be in accordance with the TAC "Guidelines for the Understanding, Use, and Implementation of Accessible Pedestrian Signals" [16]. Accessibility features must include easy-to-walk sidewalks with gradual slopes, yellow-painted dropped curbs, and directional markings on the sidewalk to assist visually impaired individuals. The pedestrian crosswalk must have "walk/don't walk" signals, countdown signals, and audio signals with touch buttons for pedestrians.

9.3 STREET NAMES

All proposed road names for new developments are to be dictated and approved by the Town. The "Street Name Reference Guide" is maintained by Heritage Penetanguishene and is available upon request from the Town.

9.4 STREET SIGNS

All traffic control signs shall be placed on the right-hand side of the roadway such that the face of the sign is perpendicular to the flow of traffic. Speed Limit Signs are to be installed according to the Town's "Traffic/Parking and the Use of Highways Regulation" by-law, as amended from time to time.

All temporary signs are to be installed after the placement of the binder course asphalt. Permanent signs and posts are to be installed prior to the initiation of the maintenance period.

Once the binder course asphalt is placed, the Developer is responsible for installing signage at all access points to the development area that says, "Unassumed Road - Use at Own Risk". The minimum size of the sign shall be 750 mm x 500 mm.

9.5 TRAFFIC SIGNAGE

All related traffic signal signing shall be as per Section 1.5.2 and the Ontario Traffic Manual [14] Books 5, 6 & 7.

9.6 TESTING

The electrical wiring and materials shall be tested according to the Canadian Electrical Code Part 1, unless otherwise specified by the Electrical Engineer and approved by the Town. The tests shall include insulation value readings and resistance to ground readings.

9.7 MATERIALS

The list of Town approved Traffic Control and Traffic Signal materials can be found in **Appendix B**.

9.8 TRAFFIC CALMING MEASURES

Traffic calming measures are to be implemented in accordance with the recommendation of the approved Traffic Impact Study or as otherwise required by the Town. Traffic Calming to conform to industry best practices.

10 UTILITIES

10.1 GENERAL

In all development or redevelopment projects, the Developer is responsible for coordination with the Town's utility providers to confirm capacity and coordinate the installation of the utilities. The providers are listed below.

Hydro

Alectra Utilities Inc.; and,

Hydro One

Telecommunications

Bell Canada and Rogers

Natural Gas

Enbridge Consumers Gas

All costs associated with the installation of utilities are the responsibility of the Developer. The Developer shall grant any easements required for access and maintenance of utilities.

10.2 COMPOSITE UTILITY PLAN

The Composite Utility Plan ('CUP') shall outline the location of all underground and above-ground services and utilities.

The Developers Engineer shall prepare a CUP and obtain the required approvals from the appropriate utility companies. A signature block for each utility provider is required on the drawing block. The CUP should be included in the set of Engineering Drawings that are submitted with the Subdivision/ Development Agreement. The utility company or their approved contractor shall install the services for all three (3) types of utilities. The CUP shall include the information shown in **Table 10-1** at a minimum.

Table 10-1 CUP Required Information

Above Ground	Below Ground
- Legal Fabric / Lot Boundaries	- Non-standard Utility Trench
- Curb and Gutter	- Sewer Service Laterals
- Driveway Location	- Water Service Laterals
- Watermain Valves (in box/ chamber)	- Rear-lot Catch Basin Leads
- Fire Hydrant	- Infrastructure Crossing the Boulevards
- Sewer Maintenance Hole	- Gas Mains
- Catchbasins	- All Road Crossings
- Sidewalks and Walkways	
- Easements	
- Hydro Transformers	
- Streetlight Standards	
- Pedestals (telephone/cable/lighting)	
- Utility Road Crossings	
- Mailbox Pads	
- Fencing	
- Any Additional Features as indicated by Town	

The Developer shall submit documented proof to the Town that each of the utility companies is satisfied with the arrangements made.

10.3 UTILITY LOCATION

All utilities are to be located underground and installed in the locations shown on the Town of Penetanguishene Standard Road Cross Section Drawings, unless otherwise approved by the Town and the applicable service provider.

The location hierarchy of municipal infrastructure and utilities shall be followed wherever possible. The hierarchy is listed in order from highest to lowest priority below.

- Municipal Watermains and Sewers
- Hydro
- Gas
- Telecommunications
- Other

Utilities are to be installed at the projection of the property lot line and pedestals and transformers are to be clustered, wherever possible.

The minimum utility clearances shall follow the values listed in **Table 10-2**, unless otherwise approved by the Town.

Table 10-2 Utility Clearances

Condition	Minimum Horizontal Distance	Minimum Vertical Distance
Utilities and Municipal Services	2.5 m	1.0 m
Utilities and Driveways	1.0 m	-
Streetlights and Transformers	3.0 m	-
Streetlights and Fire hydrants	3.0 m	-
Streetlights and Side Lot Line adjacent to RLCB leads	1.0 m	-
Transformers and Community Mailbox Pads	3.0 m	-
Generally: Utilities and Other Boulevard Features	1.0 m	-

10.4 UTILITY TRENCH

A common trench for hydro, gas, telecommunication, and cable is acceptable when implemented according to the Town Standard Road Cross Section. Warning marker tape shall be placed 0.6 m above the cables in the utility trench.

For new subdivisions, Open Cut utility trenches shall be used before the placement of curb and base course asphalt.

For existing roads, the asphalt surface shall be saw cut to allow for an Open Cut utility trench. Utility crossings shall be positioned perpendicular to the roadway wherever possible. In the event that the road or curb becomes undermined, it shall be removed and replaced.

Trenches for utilities located under the pavement structure and sidewalks shall be backfilled with granular material compacted to 100% Standard Proctor Density or as specified by a geotechnical engineer. Trenches for utilities located on boulevards and side slopes within the road allowances and easements shall be backfilled with non-organic native material compacted to 95% Standard Proctor Density or as specified by a geotechnical engineer.

10.5 ELECTRIC VEHICLES

The Ontario Building Code requires all residential properties to be equipped with an Electrical Vehicle Charging capacity.

The additional load on the electrical system must be included in the design of the entire network, including transformers and power cables.

Joint consultation with Town staff is required at the initial stage of all designs.

11 CANADA POST

The Design Engineer shall communicate with Canada Post to ensure that their requirements are included in the design. The location of all post boxes and community mailboxes must be shown on the CUP.

12 STREET LIGHTING

12.1 GENERAL

Roadways and walkways shall be lit, unless written approval by the Town is received. Streetlights are required throughout the development and may be required on roadways bordering developments if deemed necessary by the Town.

The Engineering Submission Package shall include the electrical streetlight layout and design drawings, and a detailed cost estimate.

12.2 DESIGN CRITERIA

A qualified electrical engineer shall review and seal all street lighting drawings. All designs must conform to the most current version of the Ontario Regulation 22/04 and the Electrical Safety Authority (ESA) guidelines. The Transportation Association of Canada (TAC) "Guide for Design of Roadway Lighting" and ANSI/IES RP-8-14 can be referenced for design guidelines.

Roadway intersections shall be illuminated at a level that is equivalent to the sum of the illumination levels for each of the roadways contributing to the intersection. In the event that this is not possible, subject to Town approval, the minimum illumination level must be 50% higher than the main roadway at the intersection.

Illumination levels shall be increased by 50% at high-traffic pedestrian areas, community buildings, and other high-risk intersections (i.e. railway crossings, bridges etc.).

The streetlights are to be serviced via underground wiring in ducts, with every second pole being on a secondary circuit. This would ensure 50% illumination in the event one of the circuits was compromised. The light source for roadway lighting shall be long life (minimum 100,000 hours).

The power supply for all roadway and walkway lighting shall be coordinated and arranged with Alectra and Hydro One.

12.3 LIGHT SOURCE

Street lighting units shall normally be Full Cut-off Dark Sky compliant, low-profile fixtures, photocell controlled, with no less than 6320 delivered lumens. Specific products have not been specified in **Appendix B**. Products that meet the above specification are acceptable.

In cases when the Developer wishes to install street lights having a particular style, approval for the use of such street light units shall be obtained from the Town and Alectra Utility Inc. The lighting units must conform to OPSD 2200.01 and must utilize LED light units.

12.4 LIGHT CONFIGURATION

The Town's Standard Road Cross-Sections provided in **Appendix C** and the Transportation Association of Canada (TAC) "Guide for Design of Roadway Lighting" [17] can be used to design the layout of the roadway and walkway lights.

Roadway and walkway lights at signalized intersections shall utilize joint-use traffic signal poles wherever possible.

12.5 MATERIALS

The materials used for roadway and walkway lighting must be CSA approved, unless otherwise specified by the Town. A list of Town approved Materials can be found in **Appendix B**.

12.6 INSTALLATION

The installation of the street lighting system shall be in compliance with ESA, CSA, Alectra Utility Inc. Hydro One, requirements, the Town's standards and specifications, as well as the manufacturer's installation instructions.

12.6.1 Ducts

Ducts shall be solvent welded together in trenches with a minimum cover of 750 mm. Ducts shall be surrounded by 80 mm of brick sand and warning tape to cover the width of the trench.

Duct road crossings are to be directional drilled using thick wall PVC ducts. In the event that an open-cut road crossing is necessary, the ducts shall be encased in concrete.

Installation as per OPSD 2100.06 and OPSS 603.

12.6.2 Cables

The cables shall be continuous without splices. They shall be installed after the trenches are backfilled.

Installation Specifications as per OPSS 604.

12.6.3 Fuses

The fuses in pole handholes are to be installed as per OPSD 2255.020 and OPSS 617.

12.6.4 Grounding

Ground rods shall be installed at power service disconnect (minimum 2 rods), at every fifth (5th) lighting pole, and the last lighting pole in each circuit.

Installation Specifications as per OPSS 609.

12.6.5 Poles

Installation Specifications as per OPSS 615.

12.6.6 Brackets and Luminaires

Installation Specifications as per OPSS 617.

12.6.7 Power Service Disconnect

Installation Specifications as per OPSS 614.

12.6.8 Dimming Control

Specifications as per ANSI C136.41. DIM-4 adjustable control.

13 LANDSCAPE, TREE PROTECTION, AND PARKS

Please refer to the following documents for design guidelines and information pertaining to landscape, tree protection, and parks.

- Community Design Manual
- Tree Cutting By-Law
- Tree Planting and Management Guidelines

REFERENCES

- [1] Ministry of the Environment, Conservation and Parks, "Design Guidelines for Drinking-Water Systems," 2019.
- [2] Fire Underwriters Survey, "Water Supply for Public Fire Protection," 2020.
- [3] Ontario Building Code, Ontario Regulation 332/12, 1992.
- [4] Ministry of the Environment, Conservation and Parks, "F-6-1 Procedures to Govern Separation of Sewers and Watermains," © King's Printer for Ontario, 2012–to22, 2021.
- [5] Ministry of the Environment, Conservation and Parks, "2020 Watermain Disinfection Procedure," © King's Printer for Ontario, 2012–to22, 2020.
- [6] Ministry of the Environment, Conservation and Parks, "Design Guidelines for Sewage Works," © King's Printer for Ontario, 2012–22, 2019.
- [7] Ministry of Transportation, "MTO Drainage Management Manual," © 1995-1997, Ministry of Transportation.
- [8] Ministry of the Environment, Conservation and Parks, "Low Impact Development Stormwater Management Guidance Manual," © Queen's Printer for Ontario, 1994-2022, 2022.
- [9] Ministry of the Environment, Conservation and Parks, "Stormwater Management Planning and Design Manual," © King's Printer for Ontario, 2012–22, 2003.
- [10] Ministry of Natural Resources and Forestry, "Dam Management," © King's Printer for Ontario, 2012–to22, 2021.
- [11] Toronto and Region Conservation and CH2M Hill Canada Ltd, "Inspection and Maintenance Guide for Stormwater Management Ponds and Constructed Wetlands," 2016.
- [12] Toronto and Region Conservation Authority (TRCA), "Erosion and Sediment Control Guideline for Urban Construction," Toronto and Region Conservation Authority, Vaughan, 2019.
- [13] Transportation Association of Canada (TAC), "Canadian Roundabout Design Guide," 2017.
- [14] M. Harmelink and R. Edwards, "Ontario Traffic Manual," Publications Ontario, Toronto, 2005.
- [15] Ontario, "Highway Traffic Act, R.S.O. 1990, c. H.8," 1990.

- [16] Transportation Association of Canada (TAC), "Guidelines for Understanding, Use and Implementation of Accessible Pedestrian Signals," Transportation Association of Canada, 2008.
- [17] Transportation Association of Canada (TAC), "Guide for the Design of Roadway Lighting," Transportation Association of Canada , 2006.
- [18] American Water Works Association , M31 Distribution System Requirements for Fire Protection, Fourth Edition, American Water Works Association , 2008.



Town of / Ville de
PENETANGUISHENE

Appendix A

Engineering Standard Revision

The Town of Penetanguishene
Engineering and Design Standards



Town of / Ville de
PENETANGUISHENE

Appendix B

Approved Materials List

Town of Penetanguishene
Water System Materials List

2023-05-02

THE CORPORATION OF THE TOWN OF PENETANGUISHENE

WATER DIVISION

Document Title: Town Of Penetanguishene Water Standards

Revision: 3

Author: Water Division

Approved By: M Lefaive

WQMS Reference #: PENQMS 15-42



PRODUCT	MATERIAL TYPE	SPECIFICATION*	FEATURES	MANUFACTURER	CATALOGUE #/IDENTIFIER	COMMENTS
PIPE						
Watermain up to and including 300mm diameter	Polyvinyl Chloride (PVC)	Class 150, SDR 18 AWWA C900 CSA B137.3	Push-on Joint, Colour Coded "blue", 6.1 metres in length	IPEX	Blue Brute	Factory Capped
				Royal Pipe	CIOD PVC P.P.	
				JM Eagle	Blue Brute CSA	
				Diamond Plastics Corp.	C900CSA	
				National Pipe Inc.	Dura-Blue	
Watermain 400mm Diameter	Molecularly Oriented Polyvinyl Chloride (PVCo)	AWWA C909 CSA B137.3	Push-on Joint, Colour Coded "blue", 6.1 metres in length	IPEX	Bionax	Factory Capped
Watermain 400mm Diameter	Polyvinyl Chloride (PVC), DR18	Class 150, SDR 18 AWWA C905 CSA B137.3	Push-on Joint, Colour Coded "blue", 6.1 metres in length	IPEC	Centurion	
				North American Pipe Compay (Royal Pipe)	CIOD PVC P.P.	
				Diamond Plastics Corp.	C900	
SERVICES						
Water Services	Cross-linked Polyethylene - 25mm to 50mm	AWWA C904 ASTM F876/F877 ASTM F2080 CSA B137.5 NSF-14 NSF-61	Cross-linked polyethylene (PEX) Tubing	Rehau	Municipex, Blue 904	Municipex valves and fittings conform with AWWA C800. C800 applies to "Underground Service Line Valves and Fittings" Appropriate Standard C904 "Cross Linked Poly Services" Suggest NSF Standard 14 and 61
				IPEX		
				CB Supplies Limited	CANPEX Ultra (Without Tracerwire)	
				CB Supplies Limited	CANPEX UV PLUS (Without Tracerwire)	
Corporation (Main) Stop	No Lead Alloy - 25mm to 50mm	AWWA C800 NSF-61 ASTM B-62 ASTM B-584 NSF-372	Ball Valve, Compression Joint	Cambridge Brass	301NL-A4HE4	Stainless Steel Saddles to be used on all PVC Pipe. Rockwell Type Double Solid Band Saddles for 38mm and up on DI or Cast Main. Must have a set screw for accepting tracer wire when connecting to Cross-linked Polyethylene piping.
					301NL-A6HE6	
					301NL-A7HE7	
				Ford Meter Box Company	FB1000-4-TW-Q-NL	
					FB1000-6-TW-Q-NL	
Curb Stop	No Lead Alloy - 25mm to 50mm	AWWA C800 NSF-61 ASTM B-62 ASTM B-584 NSF-372	Ball Valve, Compression Joint, Non-Draining	Mueller Canada	B-25209N	Set screw for accepting tracer wire on one nut (road side) required when connecting to Cross linked Polyethylene Service Piping
					202NL-H4HE4	
				Cambridge Brass	202NL-H6HE6	
					202NL-H7HE7	
				Ford Meter Box Company	B44-444-TW-Q-NL	
Service Boxes	Epoxy Coating Cast Iron	N/A	Extension required if special depths are encountered (as per manufacturers recommendations)	Mueller Canada	A724/A728	
					A800	
				Clow Canada	D1	
					D3	
				Bibby Ste Croix	VS B1	
Service Box Rods	Stainless Steel	N/A	36" Stainless Steel, Self Centering, Brass Cotter Pin		VS B2	
				Mueller Canada	88036	
				Clow Canada	T4-36	

Town of Penetanguishene
Water System Materials List

2023-05-02

PRODUCT	MATERIAL TYPE	SPECIFICATION*	FEATURES	MANUFACTURER	CATALOGUE #/IDENTIFIER	COMMENTS
Service Saddles	Ductile Iron Watermain (38mm to 50mm)	AWWA C800 AWWA C213 ASTM A536 ASTM D2000 ASTM A240 NSF-61	Ductile Iron, Double Strap, AWWA Tapered Threads	Smith-Blair	313	Service Saddles are mandatory on all PVC Watermain
				Ford Meter Box Company	F202	
				Robar	2408	
				Cascade	CSC2	
	PVC Watermain (25mm to 50mm)	NSF-61	Type 304 Stainless Steel including hardware, Double Bolt, Broad Band, AWWA Tapered Thread	Smith-Blair	373	
					3742	
				Ford Meter Box Company	FS303DB, FS313	
				Cambridge Brass (Teck Saddle)	Up to 400 mm Series 403DB	
				Robar	Up to 300mm 2616DB Up to 400mm 2626DB	
Cascade	CSC2					

APPROVED MANUFACTURERS' PRODUCTS FOR LINEAR WATER SYSTEMS

Feb-23

PRODUCT	MATERIAL TYPE	SPECIFICATION*	FEATURES	MANUFACTURER	CATALOGUE #/IDENTIFIER	COMMENTS
SERVICES CONTINUED						
Tapping Sleeves	Ductile Iron	ASTM D2000 ASTM A3 AWWA C223 NSF-61	Order with Stainless Steel Bolts; MJ Outlet; Epoxy Coating	Ford Meter Box Company	FTSS	
					FTSC	
				Robar	6906	
	Smith-Blair	622				
	Mueller Canada	H-621				
	PVC	AWWA C223 AWWA C207 NSF-61 ASTM D2000	Stainless Steel; MJ Outlet; Full Surround Girded Gasket	Smith-Blair	663	
Robar				6606		
Ford Meter Box Company				Fast Tap		
Couplings	No Lead Variety - 25mm to 50mm	AWWA C800 NSF-61 NSF-372 ASTM B584 ASTM B62		Mueller Canada	H-15403	No Lead Variety
				Ford Meter Box Company	C44-77	
					119NL-B4B4	
				Cambridge Brass	119NL-B6B6 119NL-B7B7	
				McDonald Brass	4758T	
Angle Meter Stops	25mm	AWWA C800 AWWA C700 ASTM B62 ASTM B584 NSF-61 NSF-372	Full Port, No Handle	Ford Meter Box Company	BA43-444W-NL	No Lead Variety
				McDonald Brass	74602B-22	
				Cambridge Brass	210NL-B4T4	
	25mm x 19mm	AWWA C800 AWWA C700 ASTM B62 ASTM B584 NSF-61 NSF-372	Full Port, No Handle	Ford Meter Box Company	BA43-342W	No Lead Variety
				McDonald Brass	4182-059	
				Cambridge Brass	210NL-B4T3	

Town of Penetanguishene
Water System Materials List

2023-05-02

PRODUCT	MATERIAL TYPE	SPECIFICATION*	FEATURES	MANUFACTURER	CATALOGUE #/IDENTIFIER	COMMENTS
FITTINGS						
Fittings	Ductile Iron + PVC	AWWA C110/A21.10 AWWA C153/A21.53 AWWA C111/A21.11 ASTM A536 NSF-61 NSF-372 AWWA C115/A21.15 ANSI B16.1 AWWA C104/A21.4	Mechanical Joint, Ductile Iron Body and Glands cement lined seal coat to AWWA C104/A21.4	TylerUnion/Biddy Sigma Star	as per manufacturer	
	Polyvinyl Chloride (PVC)	AWWA C900 AWWA C907 AWWA C905 NSF-61 CSA 137.2 & 137.3 ASTM D1784 ASTM F477 ASTM D3139	Push-on Joint CSA B137.2 (100mm to 200mm only). Must have integral joint restraint or be external mechanical restraint capable.	IPEX Royal Pipe Harrington Corp Utility Supply Corporation	Blue Brute CIOD PVC P.P. HARCO C907 RCT Flex-tite Fitting	

APPROVED MANUFACTURERS'
Feb-23

PRODUCT	MATERIAL TYPE	SPECIFICATION*	FEATURES	MANUFACTURER	CATALOGUE #/IDENTIFIER	COMMENTS
FITTINGS CONTINUED						
Fittings	All Pipe Material	AWWA C219 AWWA C111/A21.11 AWWA C153/A21.53 ASTM F1476 AWWA C227	Multi/Joint to connect different pipe materials together with similar OD ranges.	George Fischer	Multi/Joint 3000 Plus	
Couplings	Ductile Iron/PVC	AWWA C110/A21.10 AWWA C153/A21.53 AWWA C111/A21.11 ASTM A536 AWWA C115/A21.15 CSA B16.1 AWWA C104/A21.4	Mechanical Joint, Ductile Iron Body and Glands cement lined seal coat to AWWA C104/A21.4	Sigma	as per manufacturer	
	Dresser Type for DI, CI, PVC and HDPE (Use Hymax Only)		Epoxy Coated	Robar Smith-Blair TPS EBBA	as per manufacturer as per manufacturer HYMAX 3800 Mega Coupling	
	Cast Iron/Oversized Main	AWA C219 ASTM A536 ASTM D2000 AWWA C111 NSF-61	DI Bodies, Stainless Steel Nuts and Bolts	Robar Smith-Blair Dresser TPS	1406 441 as per manufacturer HYMAX 2000	
	Ductile Iron Watermain	ASTM A536 AWWA C111/A21.11 AWWA C153/A21.53 AWWA C110/A21.10 AWWA C104/A21.4 AWWA C150/A21.50	Colour Code "black" for Ductile Iron Use. Tie Rods stainless steel.	Smith-Blair Star Ford Meter Box Company Sigma Clow	Cam-Lock 111 Stargrip Uni-Flange Series 1400 One-Lok TUFGRIP-TGP	

Town of Penetanguishene
Water System Materials List

2023-05-02

PRODUCT	MATERIAL TYPE	SPECIFICATION*	FEATURES	MANUFACTURER	CATALOGUE #/IDENTIFIER	COMMENTS
Restraining Glands	PVC Watermain	AWWA C110/A21.10 ASTM A536	Tie Rods Stainless Steel. The split ring restraint design shall incorporate a series of non-directional machined serrations (not "as cast") on the inside diameter to provide positive restraint, exact fit, 360 degree contact and support of the pipe wall. *If machined serrations are directional, additional safeguards must be built into casting.	Star	Stargrip	
		AWWA C151/A21.51		Ford Meter Box Company	Uni-Flange Series 1400	
		AWWA C150/A21.50		Sigma	One-Lok, PV-Lock	
		AWWA C111/A21.11		Clow	TUFGrip-TGP	
		AWWA C153/A21.53 AWWA C909		Smith-Blair	Cam-Lock 120	
	PVCo Watermain	AWWA C110/A21.10 ASTM A536	Tie Rods Stainless Steel. The split ring restraint design shall incorporate a series of non-directional machined serrations (not "as cast") on the inside diameter to provide positive restraint, exact fit, 360 degree contact and support of the pipe wall. *If machined serrations are directional, additional safeguards must be built into casting.	Sigma	PV-LokPWPF	PVCo to PVC Fitting
		AWWA C151/A21.51			PV-LokPWPF	PVCo to PVCo
		AWWA C150/A21.50			One-Lok SLC	PVCo to Mech-Joint Fitting
		AWWA C111/A21.11			TUFGrip	PVCo to Mech-Joint Fitting
		AWWA C153/A21.53 AWWA C909			Star	StargripPVCo
Repair Clamps	Stainless Steel		All repair clamps to be supplied with stainless steel (passive 304) nuts and bolts. Tapered Gaskets.	Total Piping Solutions	EZ-Maxplus	Excluding (100mm x 19mm AWWA)
				Cambridge Brass	as per manufacturer	
				Clow Canada	Series 200	

APPROVED MANUFACTURERS'

Feb-23

PRODUCT	MATERIAL TYPE	SPECIFICATION*	FEATURES	MANUFACTURER	CATALOGUE #/IDENTIFIER	COMMENTS
VALVES						
Gate Valve	Resilient Seated Gate Valve M.J. x M.J.	AWWA C509	52mm Square Nut, M.J. x M.J. (100mm - 600mm) open counter clockwise, Resilient Seated Gate, Epoxy Coating	Mueller Canada	A2361-23	
		ASTM A536		Clow	F-6100 (A2369/2340)	
		AWWA C515				
		AWWA C550		Bibby Ste Croix	as per manufacturer	
		ASTM A126 NSF-61				
Tapping Valve	Resilient Seated Valves Tapping	C509	Flange x M.J. 150mm to 300mm, Open Counter clockwise, 52mm Square Nut, Epoxy Coated	Mueller Canada	H-687	
		ASTM A536		Clow	F-6114	
				Bibby Ste Croix	as per manufacturer	
Butterfly Valve		AWWA C504	Greater Than or Equal To 750mm Only	Pratt	Groundhog	
		AWWA C516		Crispin Valve	F47 Series	
		NSF-61 NSF-372				
Air Release	Air Release Valve Combination/Direct Bury	AWWA C512	I.P. Thread x I.P. Thread (Ball Type) 150mm Cover	A.R.I	D-090-P	
		ASTM A126 Class B			D-040-C	
		ASTM D429			S-050-C	
		AWWA C515		APCO	Model #65	
		AWWA C550		Clayton Valve	34AR-332-3/4"	
		ASTM A126 AWWA C606		Bibby Ste Croix	VB800	
Pressure Reducing	Pressure Reducing and Check Valve	AWWA C510	Flange x Flange (Note: Town of Penetanguishene to supply contractor with the appropriate pressure range)	Clayton Valve	90-01	All PRVs to be outfitted with Stainless Steel piping.
		ASTM A216		Singer Valve		
		ASTM A536				
		ASTM B148				
		ASTM B62				
		NSF-61				
Check Valve	Flexible Disc Check Valve	AWWA C508	Position Indicator, Backflow Actuator, Surge Inhibitor, Limit Switch	Henry Pratt Company	RD Series Flexible Disc Check Valve	
		ASTM A536, Grade 65-45-				
		ANSI B16.1, Class 125				
		NSF-61				
		NSF-372				

Town of Penetanguishene
Water System Materials List

2023-05-02

PRODUCT	MATERIAL TYPE	SPECIFICATION*	FEATURES	MANUFACTURER	CATALOGUE #/IDENTIFIER	COMMENTS
Valve Box		N/A	Guide Plate Extension 300mm Extension 450mm Extension 600mm; Slide Style, Upper/Lower Section	Bibby Ste Croix	VB875	Mueller MVB to be use in all areas that could experience ground frost, ie: driveways, roads, sidewalks.
					VB700	
					VB705	
					VB710	
			Mueller MVB Composite Valve Box Easily adjustable; self leveling	Mueller Canada	MVB070	
					AJBV-4D-27	
					AJBV-4C	

APPROVED MANUFACTURERS'
Mar-23

PRODUCT	MATERIAL TYPE	SPECIFICATION*	FEATURES	MANUFACTURER	CATALOGUE #/IDENTIFIER	COMMENTS
VALVES CONTINUED						
Valve Stem Extension		N/A	Required for additional depth over 1.7 metres; 52mm top operation c/w set screw; *contractor to supply required length	Bibby Ste Croix	VB950	
					VB959	
				Concord/Daigle	as per manufacturer	
				Mueller Canada	218/758 (Nut) 29/06 (Socket)	
Backflow	Reduced Pressure Principal Back Flow Preventer	AWWA C511, CSA B64.4		Zurn-Wilkins		
				Watts	#909 Series	
				Val-Matic	Swingflex 500	
HYDRANTS						
Hydrant		AWWA C502 ASME B16.1 OPSS 441 Can/ULC-S520-07 ASTM A536 ASTM B62 AWWA C502 AWWA C550	1.83 Metres (6'0") Barrel Length Chrome Yellow; Post type dry barrel compression shutoff with ball valve closing with flow; M.J. Elbow, 5" Valve Ball, 2 CSA Standard Hose Connections (2½" Nominal), 4" Storz threadless pumper connection as per NFPA 1963 and AWWA C502. Breakaway Flange, Self Draining	Clow	D67M Premier	Notes: Storz connections must be supplied by manufacturer specific to the Hydrant.
				Canada Valve	Century	
				Sigelock	Spartan	
CATHODIC PROTECTION						
Anodes	High Potential Magnesium Anode	ASTM B843 OPSS 442	Grade M1C Magnesium Anodes: 14.5kg	Interprovincial Corrosion Control	MAXMAG 17D3GG	
				Bren Technologies	Magnesium Anode	
Reference Electrode	Zinc	ASTM B418 - Type 2			as per manufacturer	
Test Station				Pro-Mark	PM-TS5	H-20 Vehicle Loading, Secure - Flush
Sacrificial Caps	Cathodic Protection (Nuts and Caps)	ASTM B418 - Type 2	99.9% High Grade Zinc, Steel Core, Coated with Low Resistant Depolarizing Material: 175 grams	Maple Agencies - Exothermal Industries	Protecto Caps 175P190	
				Duratron	DSN0750	
				Bren Technologies	SAP CAP	
				Integrity Pipeline Ltd.	Integrity Cap	
Protective Coatings	Protective Coatings for metal fittings, polyethylene encasement for ductile iron watermain pipe and fittings, Poly-Tube with overlap	AWWA C105/A21.5 AWWA C217		Interprovincial Corrosion Control	PetroWrap	
				Denso North America	Denso Wrap	
				Bren Technologies /PCS	PCS Petro Coating Systems	

Town of Penetanguishene
Water System Materials List

2023-05-02

PRODUCT	MATERIAL TYPE	SPECIFICATION*	FEATURES	MANUFACTURER	CATALOGUE #/IDENTIFIER	COMMENTS
METERING						
Water Meter 19mm - 50mm		C700-2.3m ³ /hr - 18.0m ³ /hr	Encoder Register	Sensus	Model ECR, DR	SR11, Omni (38mm, 50mm), iPeri

APPROVED MANUFACTURERS'

Feb-23

PRODUCT	MATERIAL TYPE	SPECIFICATION*	FEATURES	MANUFACTURER	CATALOGUE #/IDENTIFIER	COMMENTS
METERING CONTINUED						
Water Meter 100mm		AWWA C702 ANSI Class 125 NSF-61 NSF-372	5m ³ c/w Touch Pad Compound Meter Operating Range 1 1/2 to 320 GPM (0.11 to 72.6m ³ /h), Accuracy of 100% +/- 1.5% of Actual Thruput Flanged 3" Round Single Register to Read High and Low Flows	Sensus	4" OMNI C2/R2	Meter type to be determined based on type of use.
Water Meter 150mm		AWWA C702 ANSI Class 125 NSF-61 NSF-372	5m ³ c/w Touch Pad Compound Meter Operating Range 1 1/2 to 320 GPM (0.11 to 72.6m ³ /h), Accuracy of 100% +/- 1.5% of Actual Thruput Flanged 3" Round Single Register to Read High and Low Flows	Sensus	6" OMNI C2/R2/F2	Meter type to be determined based on type of use.
Meter Wire		CSA Type CMG, LL3996	22 Gauge 3 Conductor, Metgrey, Temperature: 60°C, Flame Rating - FT4			
Pit Setter	Plastic		Lockable Lid	Ford Meter Box Company	PTMBB-788-xx-NL MC-36HH-MB-T	Minimum Depth 1.5m
Splice Kits				3M Scotchluk	UY2 (For Meter Wire)	

AUTOMATIC FLUSHING STATIONS

Automatic Flushing Station			Lockable, with dechlorination, sampling point, 50 mm (2	Mueller Canada	Hydro-Guard HG-4 cold climate	
Automatic Flushing Station			Lockable, with siphon dechlor system and dechlor basket, sampling point, 50 mm (2 inch) inlet, 1.8 m (6	Kupferle	Eclipse 9800 cold climate model	

TRACER WIRE SYSTEMS

Tracer Wire (Open Cut Installations)			#12 AWG (0.0808" diameter) high strength copper clad steel conductor (HS-CCS) insulated with a 30mm, high density polyethylene (HDPE) insulaion, rated for direct burial use at 30 volts	Electrical Suppliers	HF-CCS PE45	Wire to be Colour Coded Blue = Water Green = Sanitary
				Canada Wire	as per manufacturer	
				Phillips	as per manufacturer	
				Maple	as per manufacturer	
				Pirrelli	as per manufacturer	
				Copperhead	as per manufacturer	
				Pro-Line	as per manufacturer	
		#12 AWG (0.808" diameter)	DomTech	260TWU121BL/260TWU121GR		
			DomTech	260RWU121BL/260RWU121GR		
Tracer Wire (Directional Drilling and Jack & Bore Installations)			Directional Drilling/Jack & Bore Installation	Copperhead	845x-EHS	For Water x=B, For Sanitary x=G Minimum of 4 wires to be pulled
				Copperhead	1045B-EHS/1045G-EHS	
				Copperhead	1245B-EHS/1245G-EHS	
Tracer Wire Connectors		ASTM D1248 ASTM B910/B910M	Water Proof Connector	Copperhead	Low Voltage Ace Connectors (SC-PB-	To be used for all Tracer Wire Connections.
Test Station (above grade)				Rhino	72" RhinoDome Test Station RDR72UU-TS9125-WPCLK	Post to be Colour Coded Blue = Water Green = Sanitary Purple = Low Impact Developments Post to contain warning sticker Water = "Warning Water Pipeline" Sanitary = "Warning Sanitary Pipe Line"
Test Station Locking Lid				Rhino	DOME-TS-LOCK	
Hydrant Three Terminal Test Station			5/8", Blue in Colour	Copperhead	Cobra T3 Hydrant Flange Package	
Flushmount Test Station			Pro-Line Tracer Pit with ISO-SWITCH5 Terminal	Pro-Line	PROTP5	
			RB14B2TSW , Blue	Copperhead	Snake Pit Switchable Access Box,	

Town of Penetanguishene
Water System Materials List

2023-05-02

PRODUCT	MATERIAL TYPE	SPECIFICATION*	FEATURES	MANUFACTURER	CATALOGUE #/IDENTIFIER	COMMENTS
APPROVED MANUFACTURERS'						
Feb-23						
PRODUCT	MATERIAL TYPE	SPECIFICATION*	FEATURES	MANUFACTURER	CATALOGUE #/IDENTIFIER	COMMENTS
MISCELLANEOUS						
Insulation	Extruded Polystyrene	ASTM C578CAN ULC S701 Type 4	Styrofoam Highload 40	Dow Chemical Canada	as per manufacturer	Minimum Strength 275kPa
Casing Spacers	Casing End Seals		Seal-Virgin SBR & Bands, T-304 Stainless Steel	Cascade	as per manufacturer	
				PSI	as per manufacturer	
				Advance (APS)	as per manufacturer	
	Casing Spacers		Fusion Coated Steel Casing Insulators	Cascade	as per manufacturer	
				PSI	as per manufacturer	
				Advance (APS)	Model SI & SSI	

*All Products are required to be certified to the newest version of the Specification.



Town of / Ville de
PENETANGUISHENE

Appendix C

Standard Design Drawings

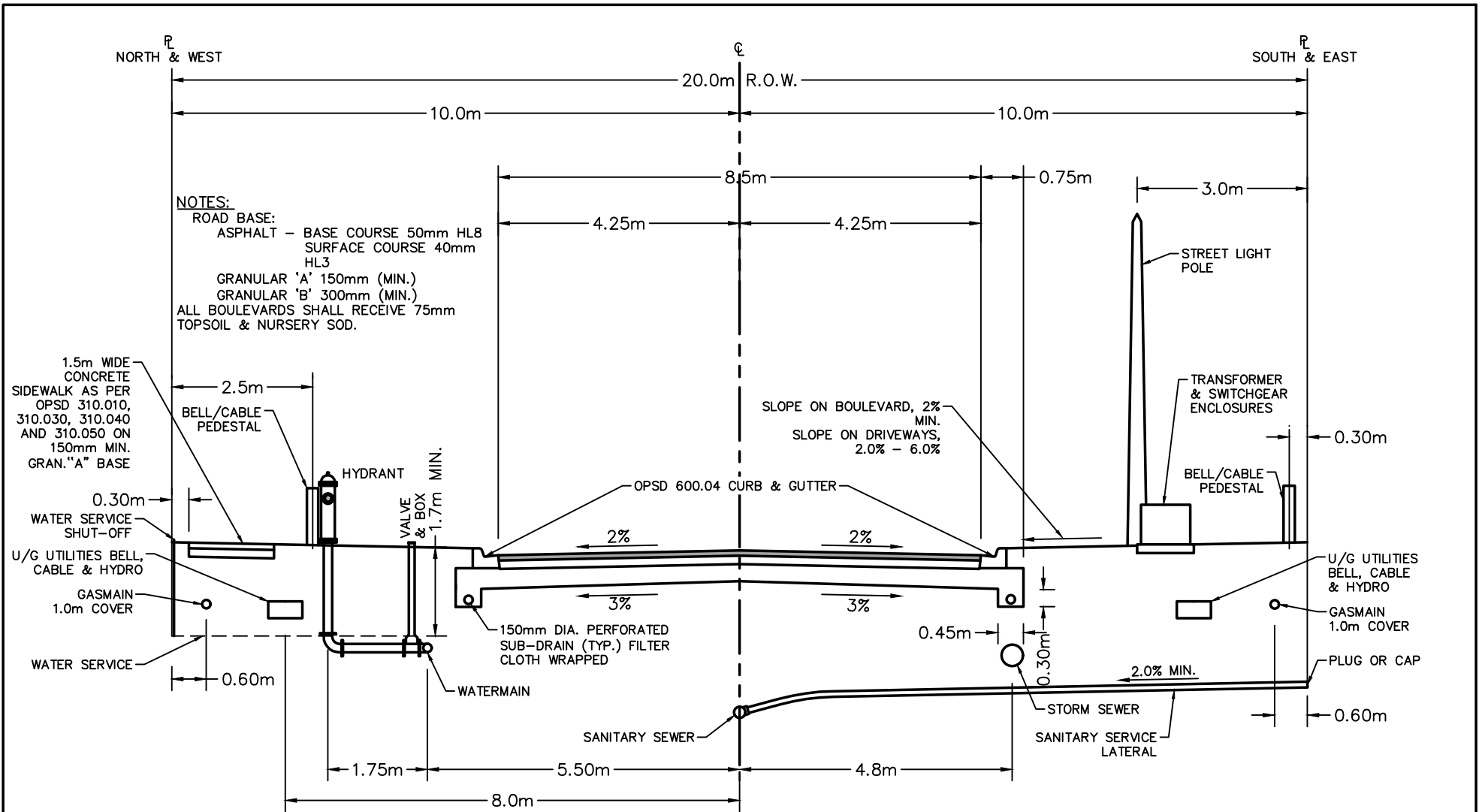

ALL DIMENSIONS IN mm UNLESS OTHERWISE NOTED

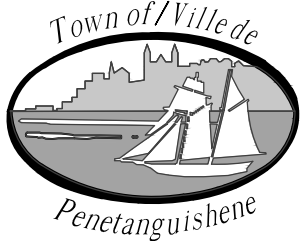

STANDARD URBAN RESIDENTIAL ROAD SECTION (20.0m R.O.W.)

TOWN OF PENETANGUISHENE

NO.	REVISIONS	BY	DATE

DRAWN: X.Z.
 SCALE: 1:100

REVIEWED BY:
 DATE: OCT 2022

DWG. NO. 1

NORTH & WEST

SOUTH & EAST

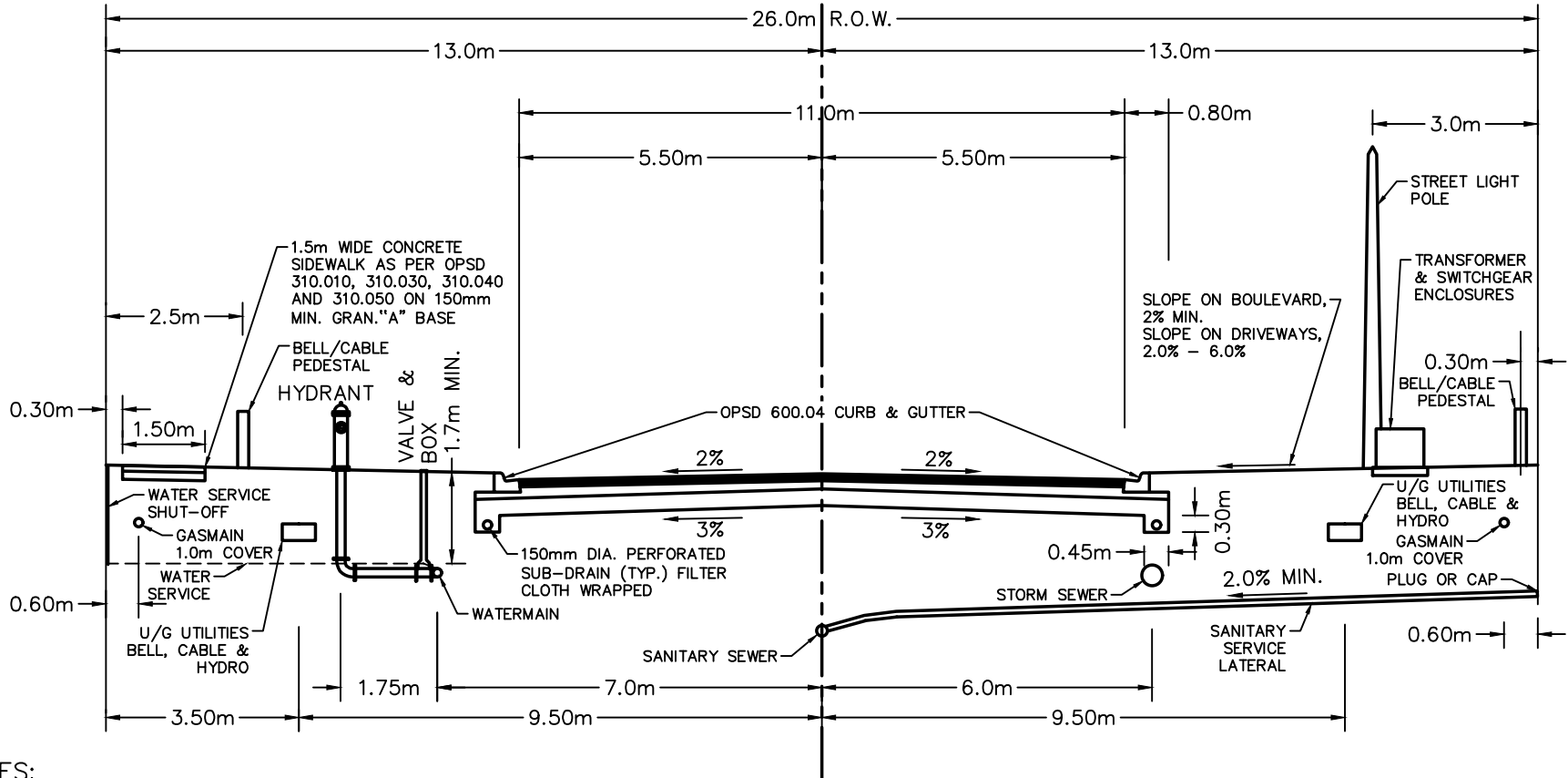

NOTES:

ROAD BASE:

ASPHALT - BASE COURSE 90mm HL8
 SURFACE COURSE 40mm HL3

GRANULAR 'A' 150mm (MIN.)

GRANULAR 'B' 300mm (MIN.)

ALL BOULEVARDS SHALL RECEIVE 75mm TOPSOIL & NURSERY SOD.

ALL DIMENSIONS IN mm UNLESS OTHERWISE NOTED



**STANDARD URBAN ARTERIAL ROAD SECTION
 (26.0m R.O.W.)**

TOWN OF PENETANGUISHENE

NO.	REVISIONS	BY	DATE

DRAWN: X.Z.

REVIEWED BY:

SCALE: 1:125

DATE: OCT 2022

DWG. NO. 2

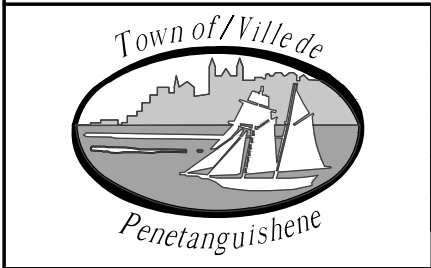
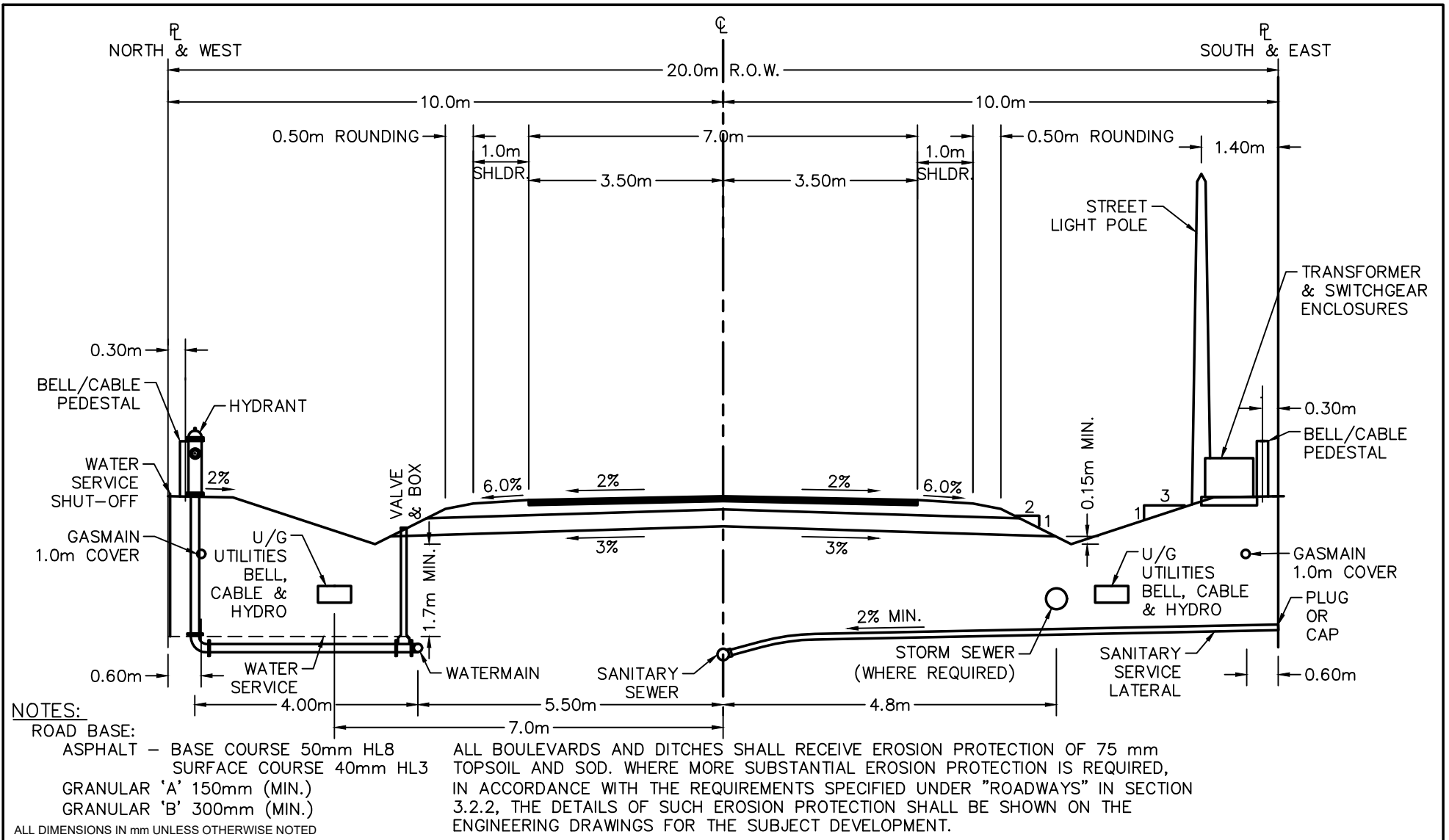

NO.	REVISIONS	BY	DATE

STANDARD RURAL RESIDENTIAL ROAD SECTION (20.0m R.O.W.)

DRAWN: X.Z.
 SCALE: 1:100

REVIEWED BY:
 DATE: OCT 2022

TOWN OF PENETANGUISHENE

DWG. NO. 3

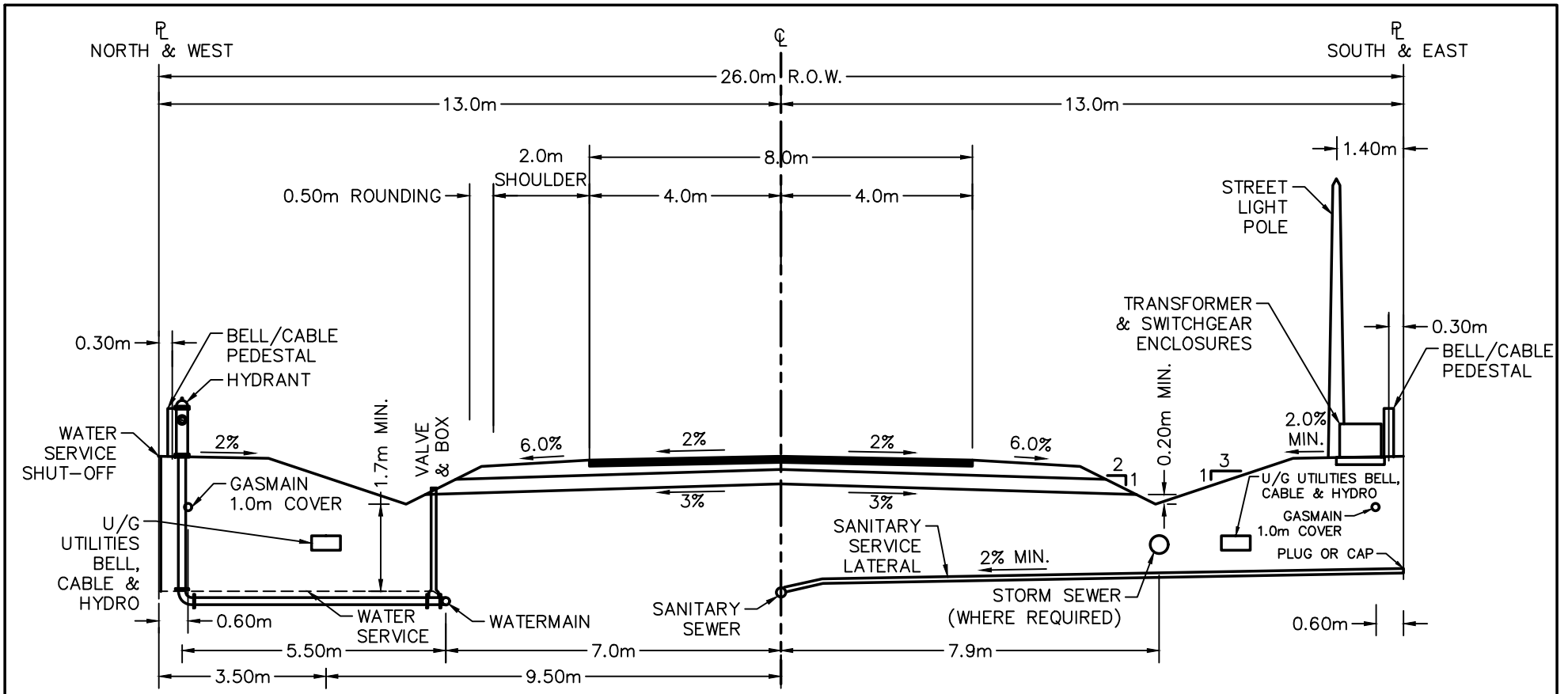

NOTES:

ROAD BASE:
 ASPHALT – BASE COURSE 90mm HL8
 SURFACE COURSE 40mm HL3
 GRANULAR 'A' 150mm (MIN.)
 GRANULAR 'B' 300mm (MIN.)

ALL BOULEVARDS AND DITCHES SHALL RECEIVE EROSION PROTECTION OF 75 mm TOPSOIL AND SOD. WHERE MORE SUBSTANTIAL EROSION PROTECTION IS REQUIRED, IN ACCORDANCE WITH THE REQUIREMENTS SPECIFIED UNDER "ROADWAYS" IN SECTION 3.2.2, THE DETAILS OF SUCH EROSION PROTECTION SHALL BE SHOWN ON THE ENGINEERING DRAWINGS FOR THE SUBJECT DEVELOPMENT.

ALL DIMENSIONS IN mm UNLESS OTHERWISE NOTED

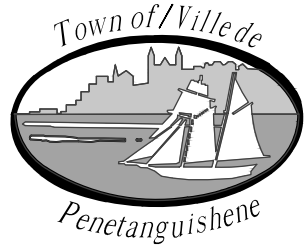

**STANDARD RURAL ARTERIAL
 ROAD SECTION
 (26.0m R.O.W.)**

TOWN OF
 PENETANGUISHENE

NO.	REVISIONS	BY	DATE

DRAWN: X.Z.
 SCALE: 1:125

REVIEWED BY:
 DATE: OCT 2022

DWG. NO. 4

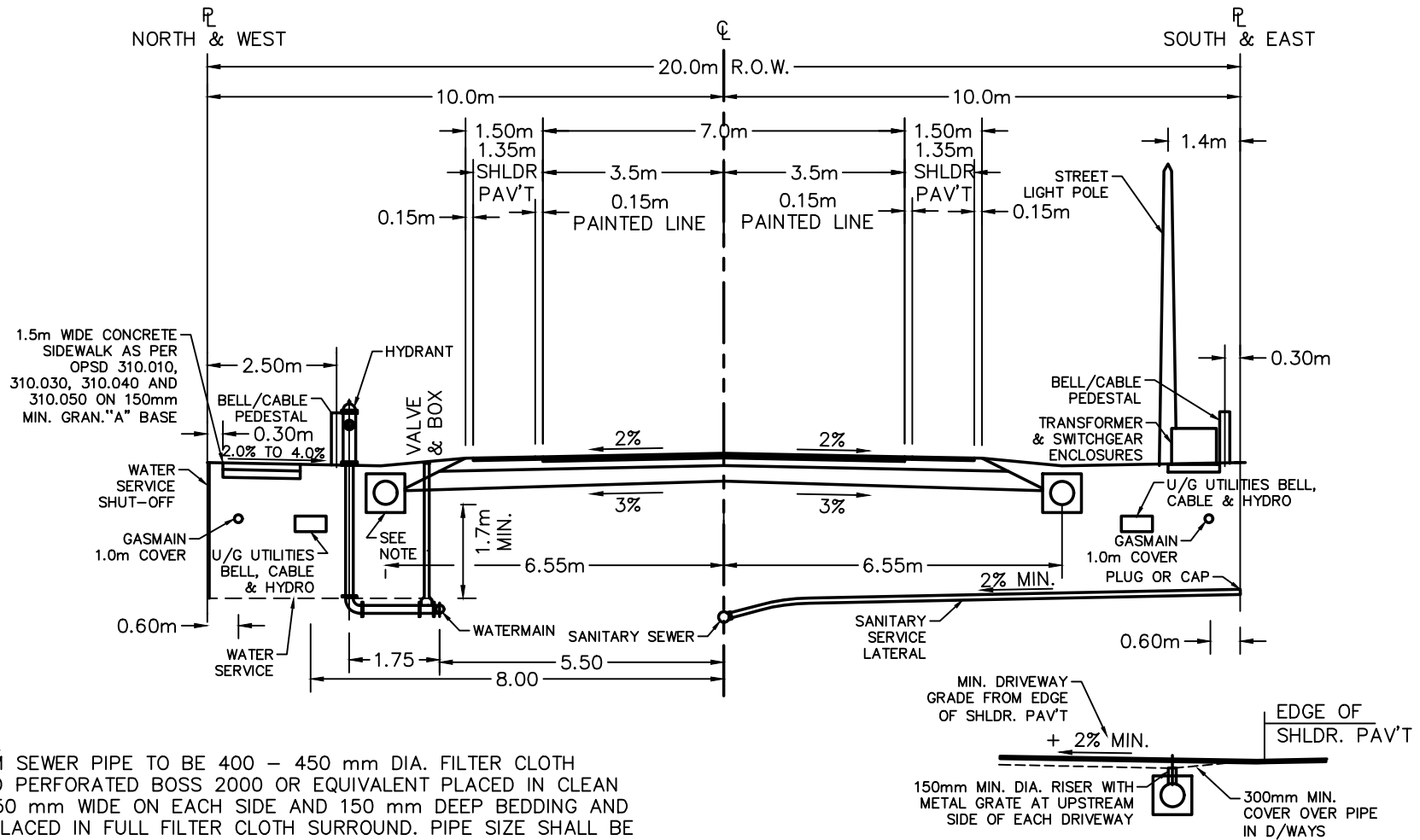

NOTES:

1. STORM SEWER PIPE TO BE 400 - 450 mm DIA. FILTER CLOTH WRAPPED PERFORATED BOSS 2000 OR EQUIVALENT PLACED IN CLEAN SAND. 150 mm WIDE ON EACH SIDE AND 150 mm DEEP BEDDING AND COVER PLACED IN FULL FILTER CLOTH SURROUND. PIPE SIZE SHALL BE DETERMINED BY ENGINEERING DESIGN. WHEN PIPE SIZE LARGER THAN 450 mm IS REQUIRED, MULTIPLE PIPES ARE TO BE USED. MAXIMUM SPACING BETWEEN MANHOLES IS 100 m.

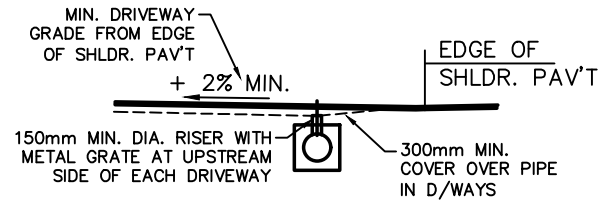

ALL DIMENSIONS IN mm UNLESS OTHERWISE NOTED



**SEMI - URBAN RESIDENTIAL
ROAD SECTION
(20.0m R.O.W.)**

TOWN OF
PENETANGUISHENE

NO.	REVISIONS	BY	DATE

DRAWN: X.Z.
SCALE: 1:125

REVIEWED BY:
DATE: OCT 2022

DWG. NO. 5

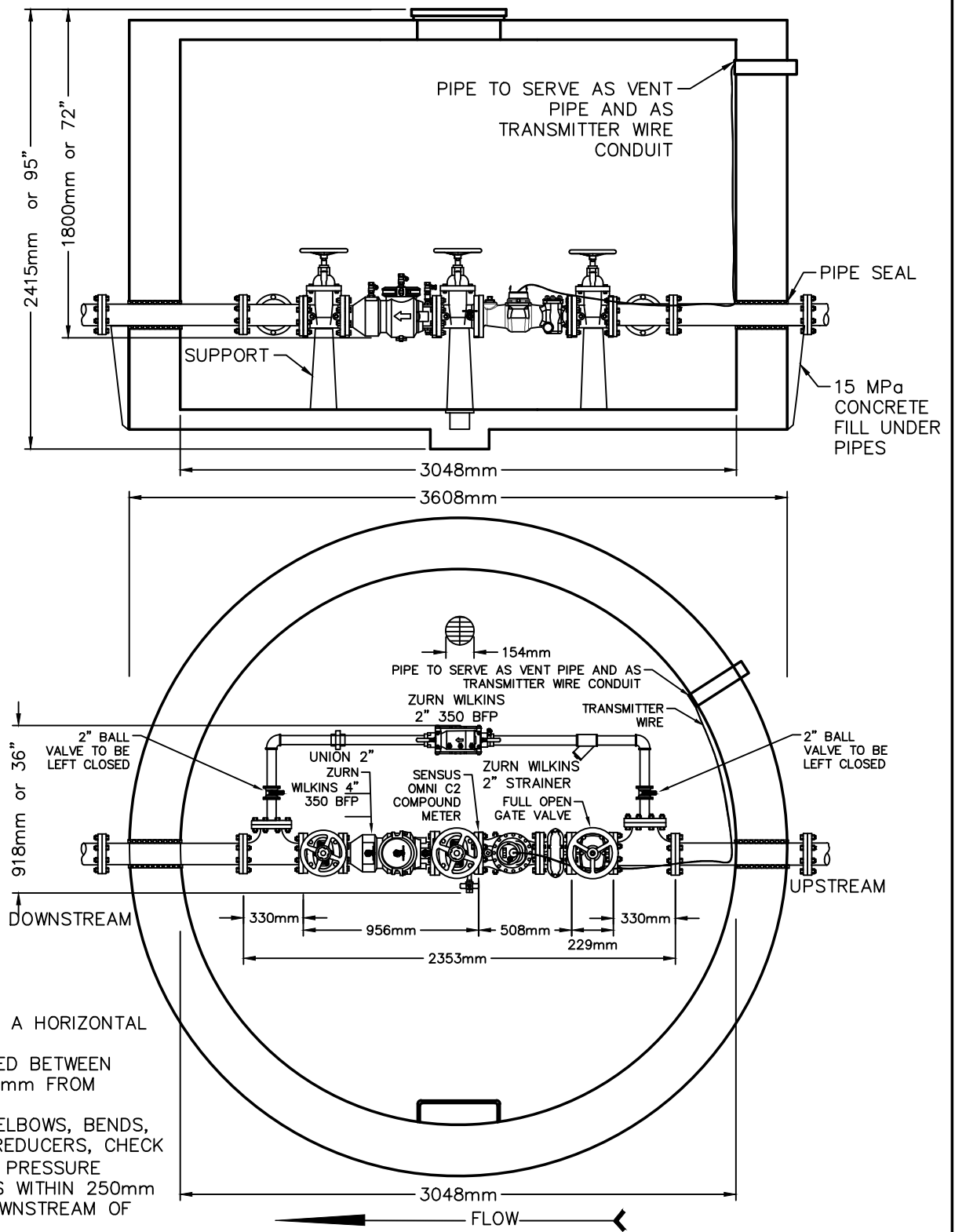

NOTE:

1. INSTALL METER IN A HORIZONTAL PLANE ONLY.
2. MUST BE INSTALLED BETWEEN 150mm AND 1200mm FROM FINISHED FLOOR.
3. DO NOT INSTALL ELBOWS, BENDS, NONCONCENTRIC REDUCERS, CHECK VALVES AND/OR PRESSURE REDUCING DEVICES WITHIN 250mm UPSTREAM OR DOWNSTREAM OF THE METER.

4. FULL OPEN FLOW COMPONENTS MAY CONSIST OF : A STRAINER, STRAIGHT PIPE, FULL OPEN GATE VALVES, BYPASS TEES AND CONCENTRIC REDUCERS(1 NOMINAL REDUCTION ONLY).
5. REMOTE TOUCHPAD TO BE LOCATED ON A 150MM DIAMETER POST IN A SUITABLE LOCATION. THE WIRE FROM THE METER TO THE POST SHALL BE PROTECTED IN CONDUIT.

ALL DIMENSIONS IN mm UNLESS OTHERWISE NOTED

NO.	REVISIONS	BY	DATE



4" METER INSTALLATION

TOWN OF PENETANGUISHENE

DRAWN: X.Z.
SCALE: N.T.S.

REVIEWED BY:
DATE: OCT 2022

DWG. NO. 6

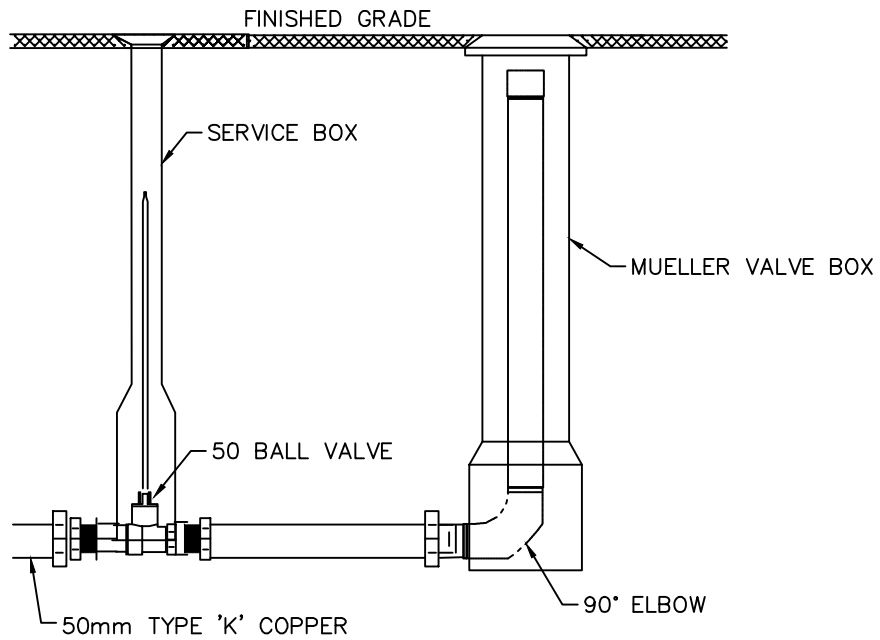

ALL DIMENSIONS IN mm UNLESS OTHERWISE NOTED

NO.	REVISIONS	BY	DATE

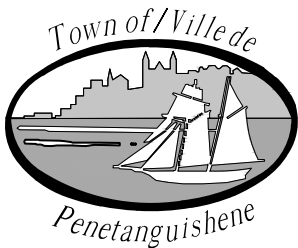

BLOW-OFF DETAIL

TOWN OF
PENETANGUSHENE

DRAWN: X.Z.

REVIEWED BY:

SCALE: 1:15

DATE: OCT 2022

DWG. NO. 7

BLOW-OFF AND DISCHARGE MEASURING

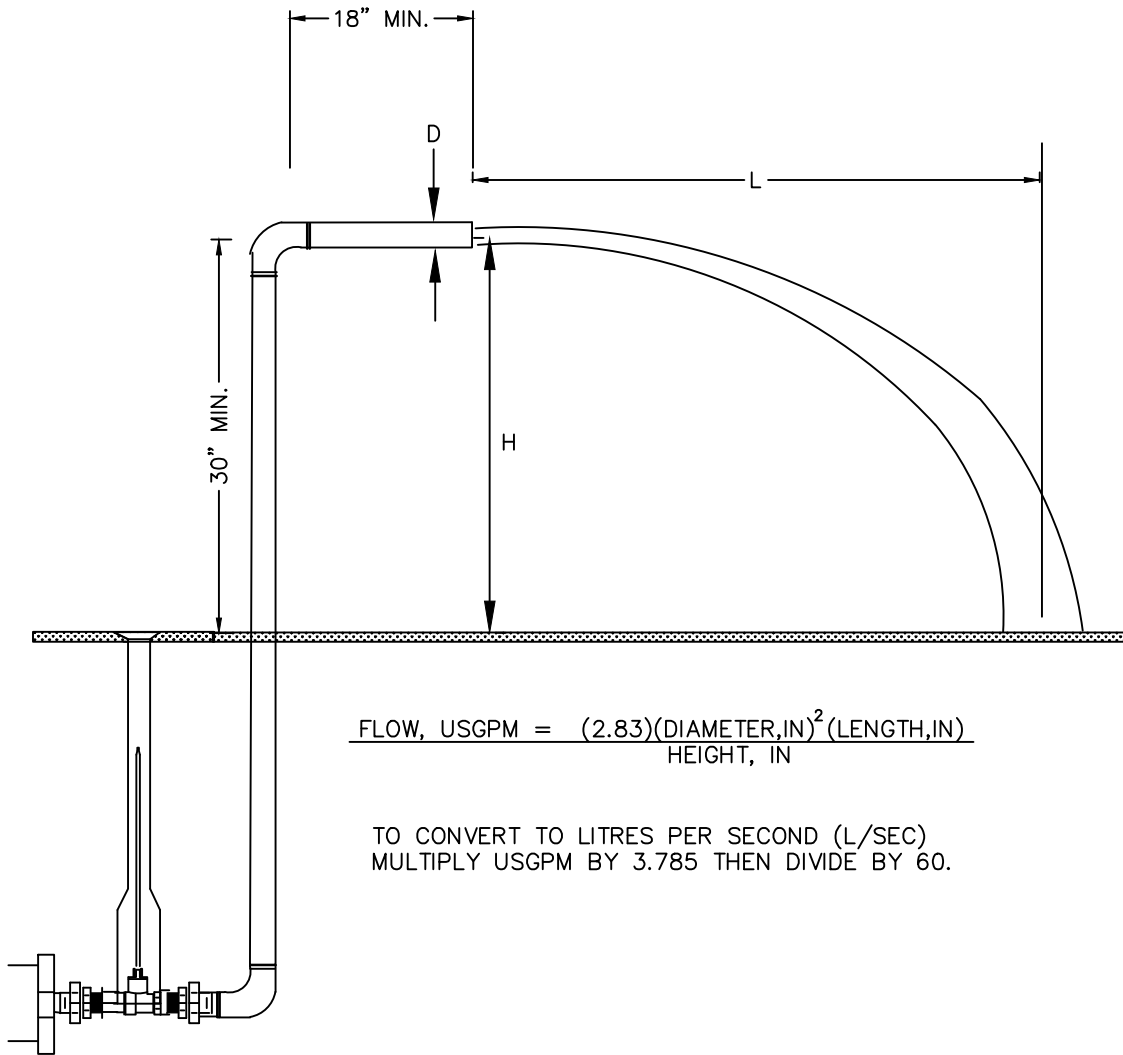

$$\text{FLOW, USGPM} = \frac{(2.83)(\text{DIAMETER, IN})^2 (\text{LENGTH, IN})}{\text{HEIGHT, IN}}$$

TO CONVERT TO LITRES PER SECOND (L/SEC)
MULTIPLY USGPM BY 3.785 THEN DIVIDE BY 60.

NEW WATERMAIN TESTING PROCEDURE _ APPENDIX "B"

ALL DIMENSIONS IN mm UNLESS OTHERWISE NOTED

NO.	REVISIONS	BY	DATE



BLOW-OFF AND DISCHARGE MEASURING

TOWN OF
PENETANGUISHENE

DRAWN: X.Z.

REVIEWED BY:

SCALE: 1:15

DATE: OCT 2022

DWG. NO. 8

NOTE:

- A. USE MULTI-PURPOSE PIPE RESTRAINING SYSTEM ROMAC INDUSTRIES (1-800-426-9341) 600 SERIES AS APPLICABLE. THRUST BLOCKS NOT ALLOWED.
- B. BOLTS FOR BURIED FLANGE TO FLANGE CONNECTIONS ARE TO BE STAINLESS STEEL.
- C. ALL DIMENSIONS ARE IN MILLIMETERS UNLES OTHERWISE SHOWN.

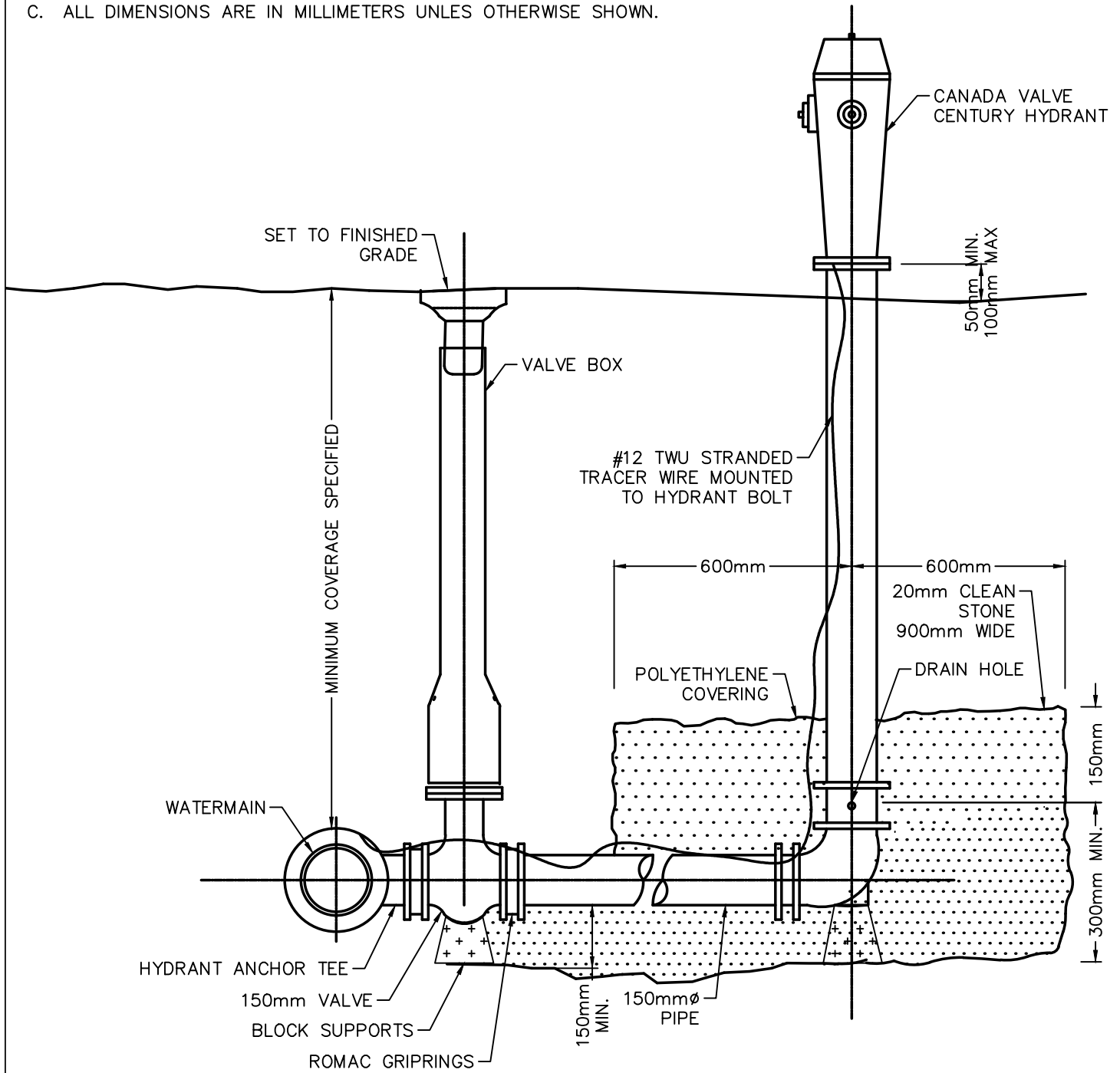

ALL DIMENSIONS IN mm UNLESS OTHERWISE NOTED

NO.	REVISIONS	BY	DATE



FIRE HYDRANT DETAIL

TOWN OF
PENETANGUISHENE

DRAWN: X.Z.

REVIEWED BY:

SCALE: 1:15

DATE: OCT 2022

DWG. NO. 9

NEW WATERMAIN TEMPORARY CONNECTION

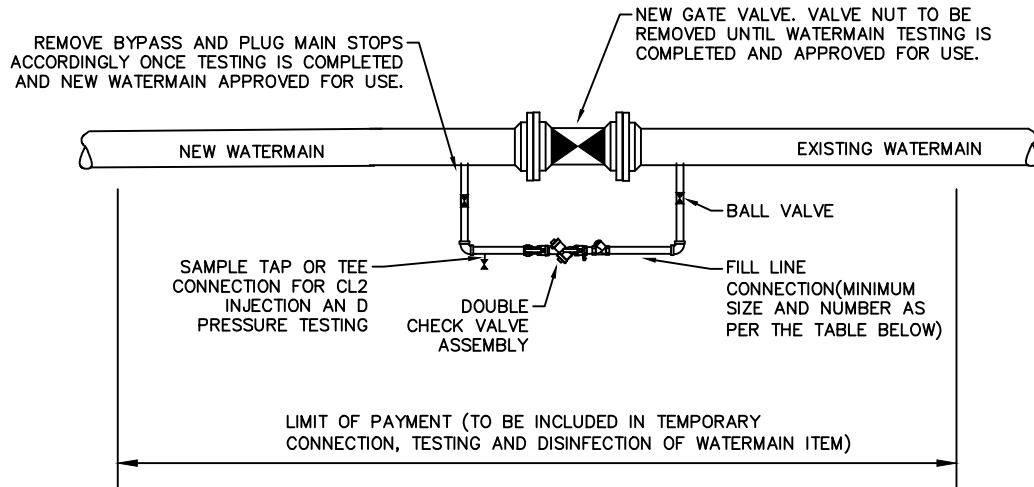

PIPE DIAMETER	FLOW REQUIRED TO PRODUCE 2.5FT/S (0.76M/S) (APPROX.) VELOCITY IN MAIN	SIZE OF TAP IN. (MM)			NUMBER OF OPEN 2½-IN. (64MM) HYDRANT OUTLETS
		1 (25)	1½ (38)	2 (51)	
In. – mm	Gpm – l/s	Number of Taps on Pipe			
4 – 100	100 – 6.3	1	–	–	1
6 – 150	200 – 12.6	–	1	–	1
8 – 200	400 – 25.2	–	2	1	1
10 – 250	600 – 37.9	–	3	2	1
12 – 300	900 – 56.8	–	–	2	2
16 – 400	1600 – 109.9	–	–	4	2

REQUIRED FLOW AND OPENINGS TO FLUSH PIPELINES (276kPa/40 PSI RESIDUAL PRESSURE IN WATERMAIN). A MINIMUM VELOCITY OF 2.5ft/s (0.76m/s) WHEREVER POSSIBLE TO ALLOW FOR PROPER FLUSHING.

NEW WATERMAIN TESTING PROCEDURE – APPENDIX "A"

ALL DIMENSIONS IN mm UNLESS OTHERWISE NOTED

NO.	REVISIONS	BY	DATE



NEW WATERMAIN TEMPORARY CONNECTION

TOWN OF
PENETANGUISHENE

DRAWN: X.Z.
SCALE: N.T.S.

REVIEWED BY:
DATE: OCT 2022

DWG. NO. 10

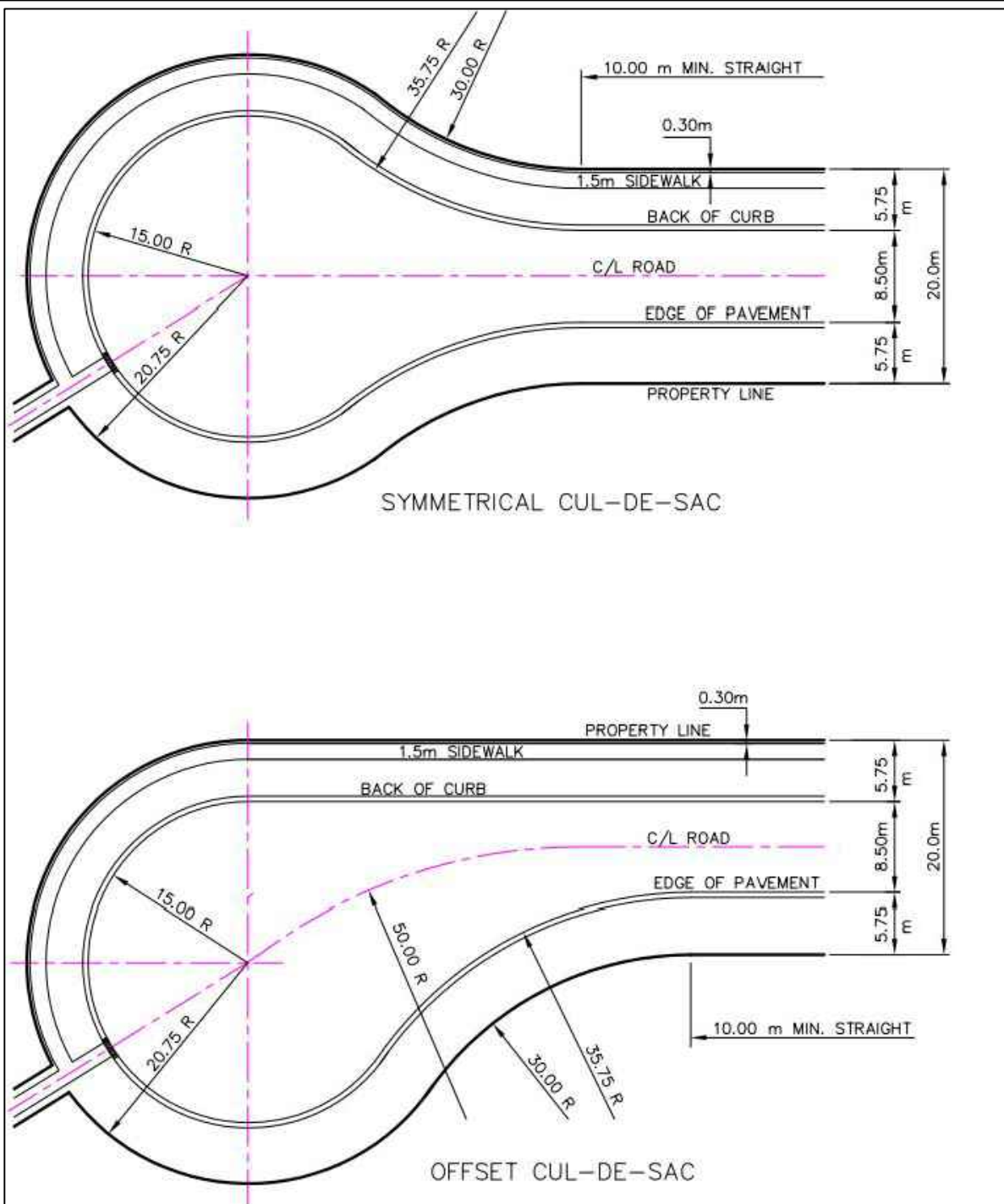

ALL DIMENSIONS IN mm UNLESS OTHERWISE NOTED

NO.	REVISIONS	BY	DATE



**PERMANENT URBAN
RESIDENTIAL CUL-DE-SAC
(20.0m R.O.W.) DETAIL**

TOWN OF
PENETANGUSHENE

DWG NO.11

DRAWN: H.E.
SCALE: 1:50

REVIEWED BY:
DATE: FEB 2023

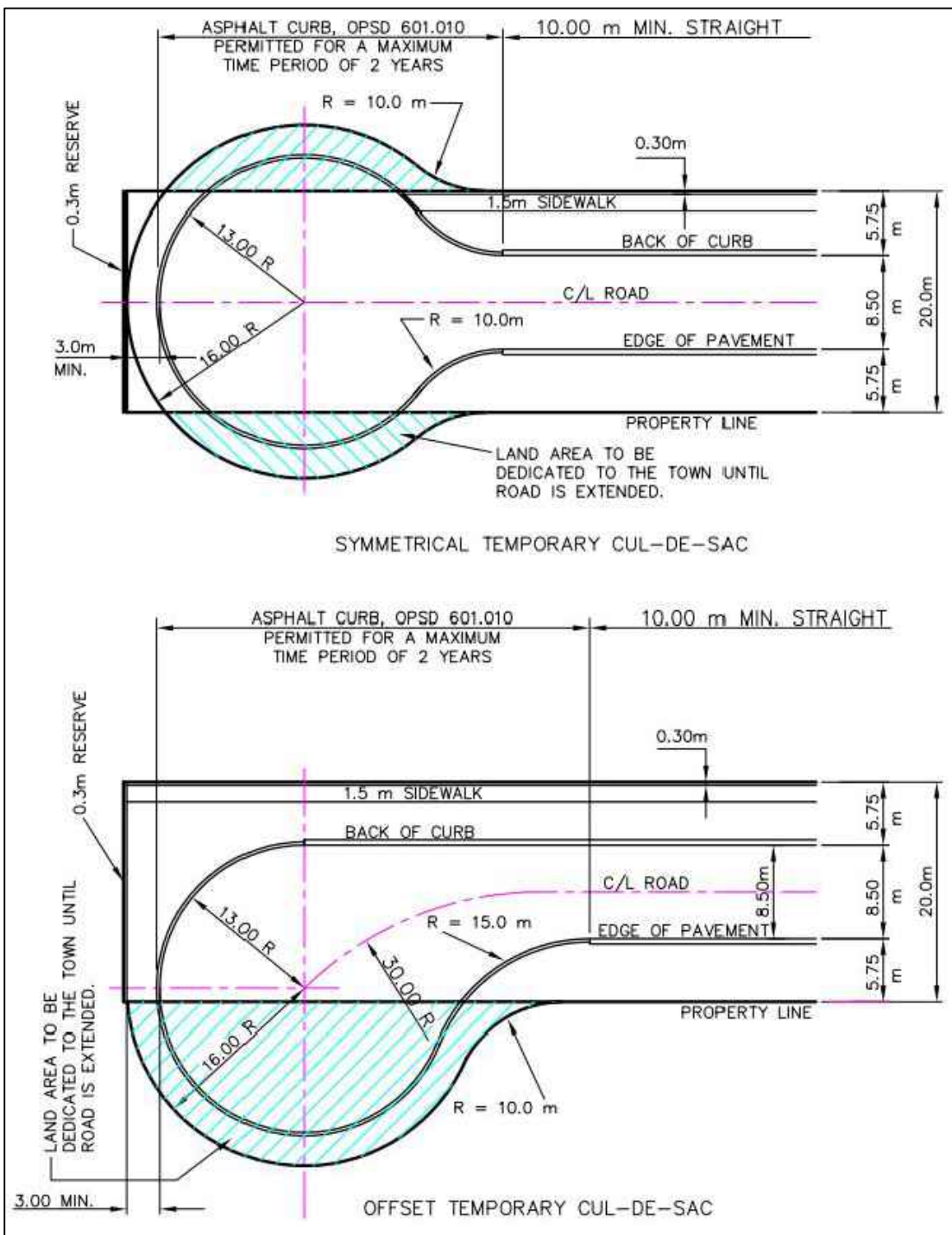

ALL DIMENSIONS IN mm UNLESS OTHERWISE NOTED

NO.	REVISIONS	BY	DATE



TEMPORARY URBAN
RESIDENTIAL CUL-DE-SAC
(20.0m R.O.W.) DETAIL

TOWN OF
PENETANGUIHENE

DWG NO.12

DRAWN: H.E.
SCALE: 1:50

REVIEWED BY:
DATE: FEB 2023

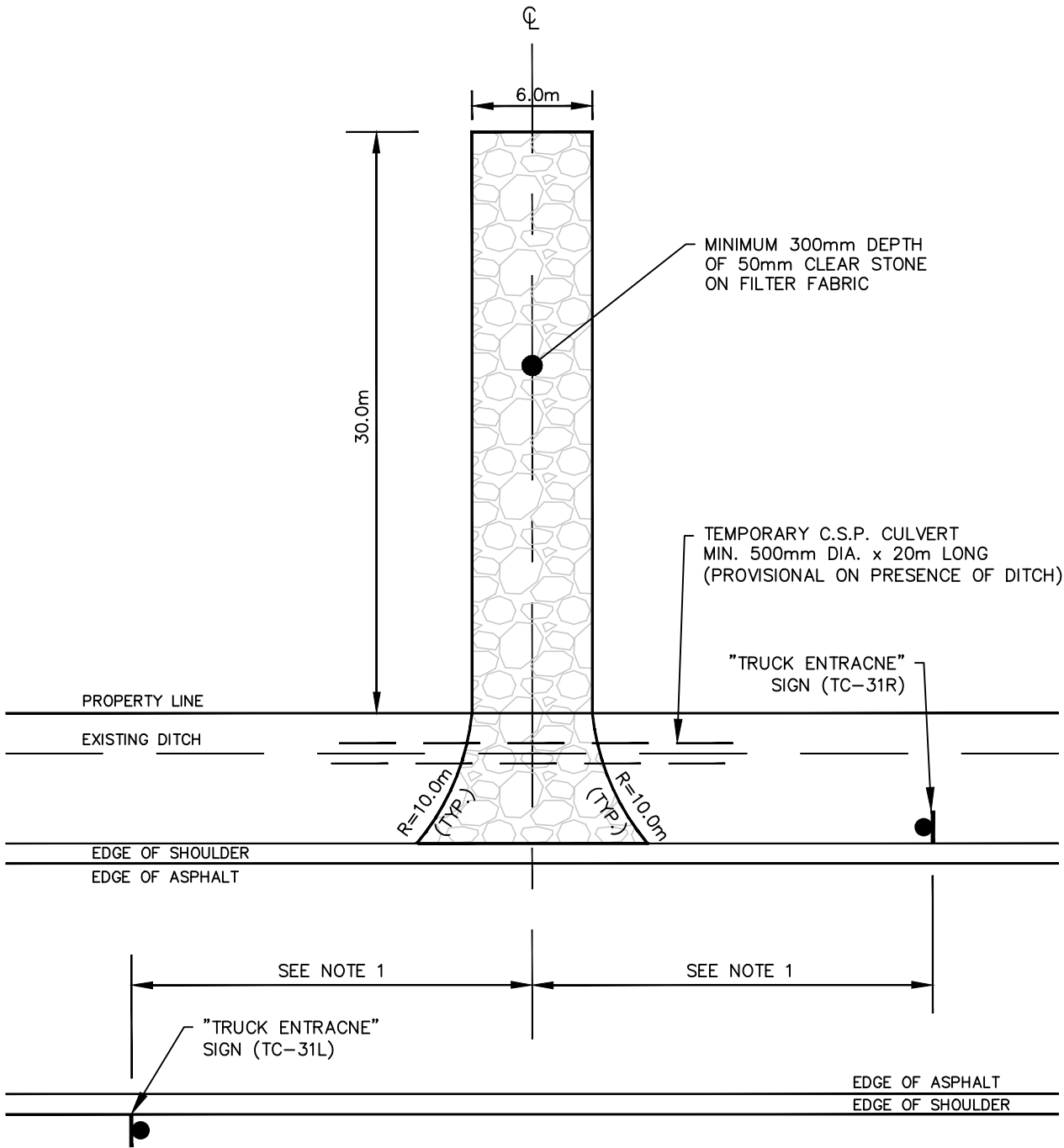

NOTES

1. TEMPORARY "TRUCK ENTRANCE" SIGNS (TC-31) SHALL BE INSTALLED ON THE SHOULDER, 150m IN ADVANCE OF THE CONSTRUCTION ACCESS. THE APPLICANT WILL BE RESPONSIBLE FOR THE COST OF OBTAINING, ERECTING AND MAINTAINING THESE SIGNS.
2. THE TEMPORARY CONSTRUCTION ACCESS SHALL BE REMOVED FROM THE ROAD ALLOWANCE WHEN ITS USE IS FINISHED AND ALL DISTURBED AREAS SHALL BE RESTORED TO ORIGINAL OR BETTER CONDITION

ALL DIMENSIONS IN mm UNLESS OTHERWISE NOTED

NO.	REVISIONS	BY	DATE



**TEMPORARY CONSTRUCTION
ACCESS DETAIL**

TOWN OF
PENETANGUISHENE

DRAWN: H.E.
SCALE: N.T.S.

REVIEWED BY:
DATE: FEB 2023

DWG NO.13

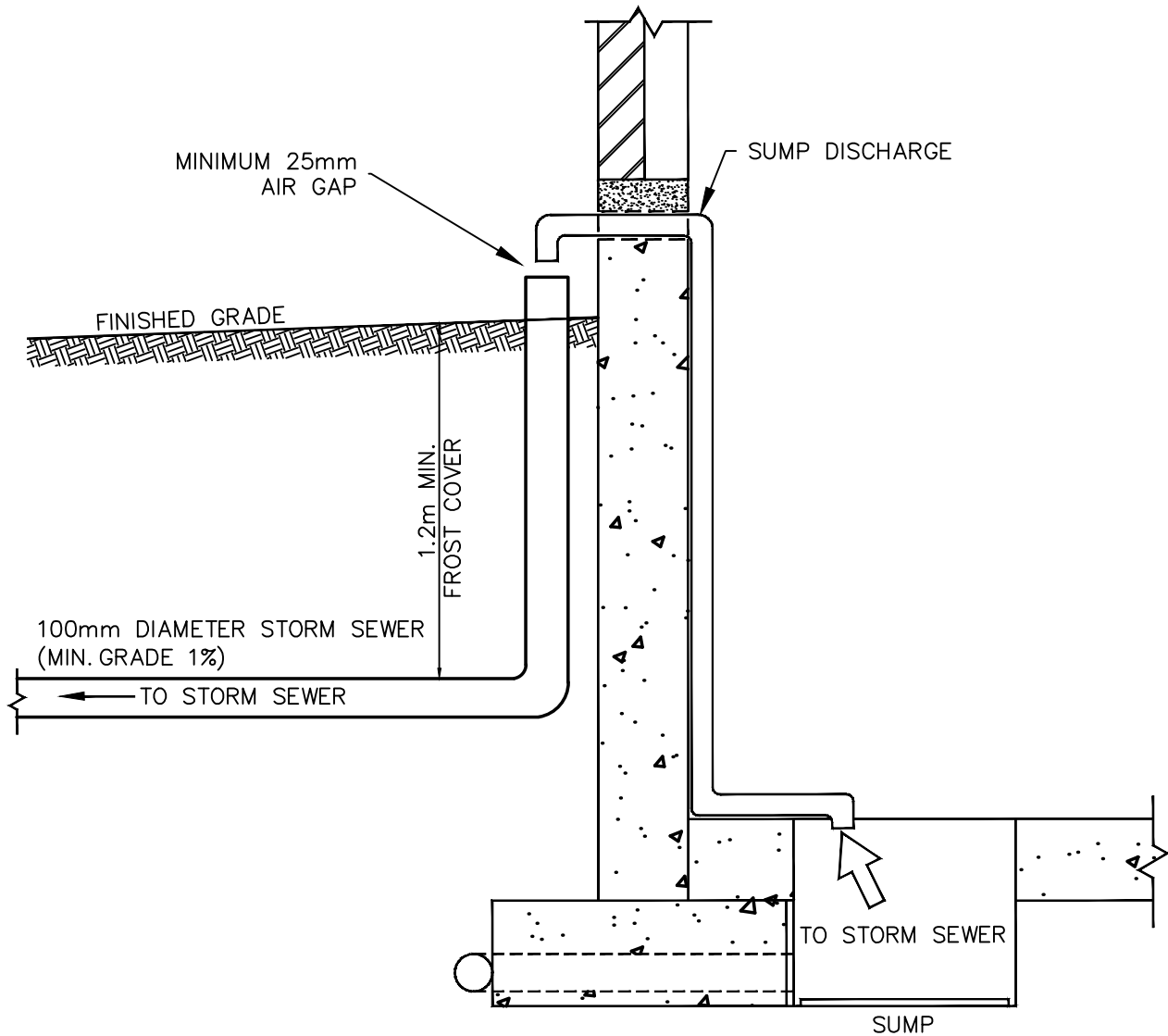

NOTES

1. PIPE SHALL BE 100mm DIA. PVC SDR28 WHITE SEWER PIPE.
2. MIN. SLOPE OF PIPE TO BE 1%.
3. JUNCTION OF SUMP DISCHARGE AND STORM SERVICE MUST BE 100mm ABOVE FINISHED GRADE AND IS NOT TO BE SEALED.
4. SUMP DISCHARGE PIPE TO BE CONNECTED TO THE SUMP PUMP AND FASTENED AS PER PART 7 OF THE ONTARIO CODE.

ALL DIMENSIONS IN mm UNLESS OTHERWISE NOTED

NO.	REVISIONS	BY	DATE

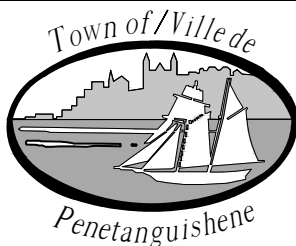

RESIDENTIAL STORM SEWER CONNECTION (100mm) DETAIL

TOWN OF PENETANGUISHENE

DRAWN: H.E.
SCALE: N.T.S.

REVIEWED BY:
DATE: FEB 2023

DWG No. 14

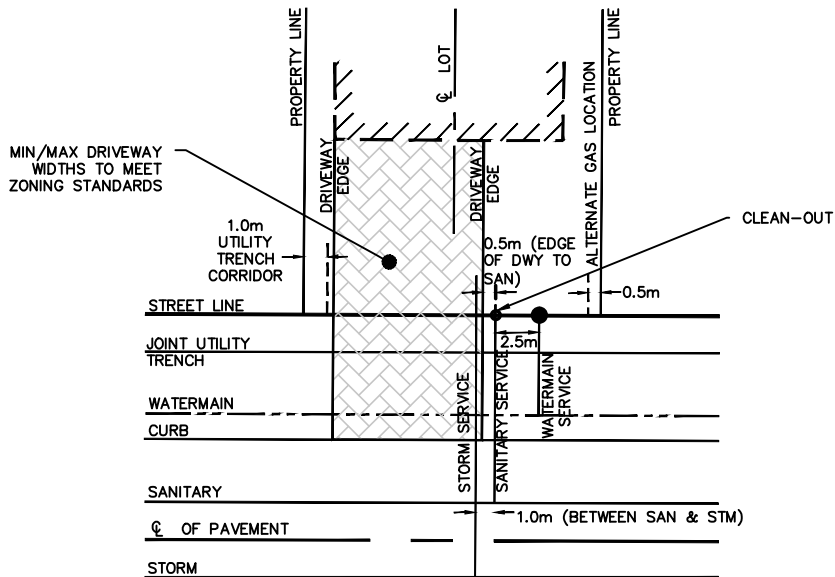

SINGLE DETACHED SERVICE CONNECTION

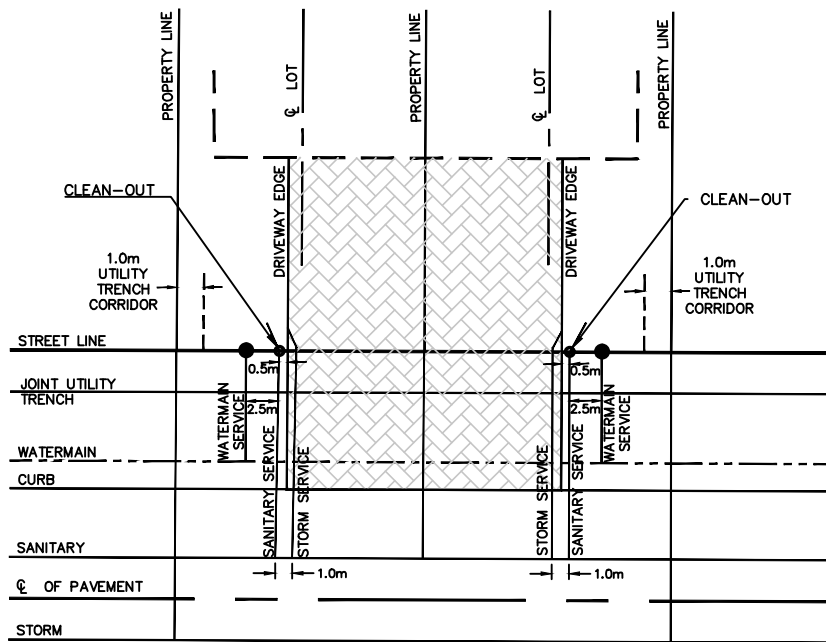

SEMI-DETACHED SERVICE CONNECTION

NOTES

1. CLEAN OUT REQUIRED AT PROPERTY LINES FOR ALL SANITARY SERVICES. CLEAN OUT SHALL CONSIST OF 125mm x 125mm x 100mm 45° WYE COMPLETE WITH 100mm 45° BEND & 100mm RISER WITH WATERPROOF CAP AT SURFACE.

ALL DIMENSIONS IN mm UNLESS OTHERWISE NOTED

NO.	REVISIONS	BY	DATE



TYPICAL SERVICE ARRANGEMENT DETAIL

TOWN OF PENETANGUISHENE

DRAWN: H.E.
SCALE: N.T.S.

REVIEWED BY:
DATE: FEB 2023

DWG No. 15



Town of / Ville de
PENETANGUISHENE

Appendix D

Watermain Commissioning Procedure



1. PROCEDURE

1.1 This procedure shall be used for commissioning all new watermain.

Note: Any time chlorinated water is to be directed into the natural environment, tests must be conducted to ensure that the chlorine residuals being released will not harm the environment to which they are being directed. (ex. less than 0.02 mg/l for wetlands and other sensitive areas). De-chlorination with Sodium sulfite may be necessary.

2. ORDER OF PROCEDURES

This procedure consists of the following tasks:

- Temporary Connection from New Watermain to Existing Watermain
- Appurtenance checks
- Loading with Water, Swabbing and Flushing
- Pressure Testing
- Disinfection
- Final Flushing and Disposal of Treated Water
- Bacteriological Sampling and Analysis
- Final Connection
- Commissioning

- Appendix "A" – New Watermain Temporary Connection Drawing
- Appendix "B" – Blow-Off and Discharge Measuring Drawing
- Appendix "C" – Watermain Commissioning Checklist

Please use Watermain Testing Tools that can be found on <Q:\Server\Water Division\Excel\Watermain Testing Tools.xls>. or alternatively on Compliance Science. All the necessary formulas can be found in this spreadsheet for ease of use.

Temporary Connection from New Watermain to Existing Watermain

2.1 The Town of Penetanguishene requires that a temporary connection be provided when connecting a new watermain to an existing watermain. This connection will be installed under supervision of a certified water distribution operator employed by The Corporation of the Town of Penetanguishene as per the detailed drawings shown in Appendix "A" of this procedure.



- 2.2 This temporary connection configuration allows the contractor to use the town's water supply without the assistance of a certified operator.
- 2.3 Fire Hydrants or Temporary blow-offs shall be installed at every end of the new watermain for the purposes of swabbing, flushing and super chlorination as per the drawing shown in Appendix "B" of this procedure.

Appurtenance Checks

- 2.4 Any watermain being installed must be checked to confirm that it is NSF60/61, ANSI certified or ULC listed. The pipe must also be checked to confirm the type of pipe. A random selection pipes to be installed can be observed to qualify this requirement.
- 2.5 It is important to check the operating condition of any valves once they are installed. Using the Wachs Valve Turner, the valve should be exercised to a full open and then full closed position to initially identify the required torque to operate the valve. Mueller valves for example state that the maximum torque required to operate a new valve is 110 ft-lbs for a 6" valve and 150 ft-lbs for an 8" valve.
- 2.6 Provided the valve operates to a full open and closed position with less than the required maximum torque for a new valve, the operator must then confirm that the valve can handle the maximum allowed torque. For the purpose of this exercise, each valve must be tested at 300 ft-lbs in a closed position to verify the materials used to build the valve are manufactured to the necessary standards.
- 2.7 Also to be noted is the condition of the valve prior to installation. Note if there are any cracks in the epoxy finish or obvious signs of neglect or damage.

Loading With Water, Swabbing and Flushing

- 2.8 Each section of new watermain shall be cleaned with a minimum of 2 swabs. Swabs shall be 50mm greater than the inside diameter of the new pipe they are intended to clean and must be at least 1.5 times in length than the diameter. They shall also be numbered to ensure proper retrieval. The new watermain shall be loaded slowly at a maximum flow rate of 0.3m/sec (1ft/sec). Once the swab(s) have been discharged from the watermain(s), the flow rate shall be increased to a minimum of flow rate of 0.76m/sec or 2.5ft/sec until the Turbidity is measured below 5.0 NTU.



- 2.9 Flushing water shall be discharged without causing erosion damage, nuisance or interruption of traffic. Ensure free chlorine residuals are safe for release to natural environment.

Hydrostatic Leakage Testing

- 2.10 Prior to the contractor undertaking the Hydrostatic Leakage Test with a Town of Penetanguishene Water Division representative on site, the contractor shall perform a preliminary test to ensure there are no major leaks or air remaining in the system.
- 2.11 Hydrostatic Leakage Testing supervision shall be undertaken by authorized inspectors or Water Division staff only. All new watermains and appurtenances shall be pressure tested at a minimum of 1035 kPa (150 psi) at the highest point in the tested system. If the highest point of the tested system is at a location other than where the test pump is located, a pressure gauge will suffice at the highest point of the tested system.
- 2.12 All watermain valves shall be checked to ensure they are open or closed as would be required for the leakage test and to ensure all new valves are in good working condition. New fire hydrant isolation valves within the test area must be open and service valves must be closed at property line.
- 2.13 The container that will serve as the pressurizing water container and sodium hypochlorite mixing container shall be inspected by authorized staff of the Town of Penetanguishene to ensure it is of satisfactory condition and cleanliness.
- 2.14 The pressure and leakage test shall last for a minimum of two (2) hours at 1035 kPa (150 psi). The test pressure at the test pump shall be recorded upon commencement of the pressure test. Once the two (2) hour period has elapsed, the residual static pressure shall be recorded. The watermain shall then be pumped back up to the original test pressure at the start of the test and the volume used from the container shall be recorded.
- 2.15 The volume in the pressurizing water container can be determined by the following formula $V = 0.785 D^2 \times H$, Where $V =$ Volume, $D =$ diameter and $H =$ Height. Volume per units selected can then be determined by dividing the volume of the cylinder (L) by the height of the cylinder.
- 2.16 When refilling this vessel to its pre-pressure test volume, a flask or container with incremented volume indicators is necessary to determine leakage.



- 2.17 The allowable leakage formula used shall be in accordance with AWWA C605-94 Standard for Hydrostatic Testing. $L_m = \frac{NDVP}{130,400}$
- 2.18 Where "Lm" equals the allowable leakage, in litres per hour; "N" is the number of joints in the length of pipeline tested; "D" is the nominal diameter of the pipe, in millimetres; and "P" is the average test pressure during the leakage test, in kPa.
- 2.19 The formulas are also available in an Excel spreadsheet named "Watermain Testing Tools.xls". This spreadsheet was created by the Town of Penetanguishene Water Division and can be found on the network server at 22 Centennial Drive or alternatively on Compliance Science.

Disinfection

- 2.20 Any Sodium or Calcium Hypochlorite products used in the process of superchlorinating new watermains must comply with AWWA B300 and NSF 60/61 standards. New watermains and appurtenances shall be disinfected in accordance with Ontario Watermain Disinfection Procedure.
- 2.21 The entire watermain, fire hydrant leads and all services shall be filled with heavily chlorinated water with a minimum Cl₂ Free residual of 50 mg/l at all points in the new system. After which time all gate valves are to be cycled and services are to be bled off. The chlorinated water shall be retained in the watermain for at least 24 hours. At the end of the 24 hour period, the treated water shall have a Free Cl₂ residual not less than 25mg/l at all measurable points in the new system.

Final Flushing and Disposal of Treated Water

- 2.22 After the requirements of the disinfection have been met, the superchlorinated water shall be completely flushed from the new watermain and appurtenances until the Free Cl₂ residuals are consistent with the Town's distribution system.
- 2.23 The environment to which the chlorinated water is to be discharged shall be inspected to ensure the protection of aquatic life. Only under the following conditions will the discharge of superchlorinated waters be permitted:
- To a sanitary sewer manhole. This is only permissible when notice has been given to the affected sewage treatment plant and the rate of discharge is low ex. one or two ¾" services through manhole cover holes. If the biological process is upset in any way, this method shall cease immediately.



- Open ditches and vegetated fields are acceptable discharge locations as long as there is a considerable distance (Greater than 300 meters) to the receiving waters. Testing the Cl₂ Free Residuals at a point significantly downstream is also recommended.
- A large excavation is also a great location to dispose of treated waters.

2.24 If these conditions are not available, dechlorination will be required. There are a number of chemicals available for dechlorination but the preferred chemicals are:

- Hydrogen Peroxide (Factor = 0.479). This is the preferred chemical because it is very effective, inexpensive and an overdose will only add more oxygen to the watercourse.
- Sodium Sulfite (Factor = 1.775). This chemical is often used with dechlorinating diffusers which are widely used.
- Sodium Thiosulphate (Factor = 2.225). This will cause some sulphur turbidity but an excess is harmless.

Bacteriological Sampling and Analysis

2.25 After the requirements of the previous sections have been met, two consecutive sets of water samples shall be taken 24 hours apart. The first set being taken 24 hours after the superchlorinated water has been disposed of. Samples shall be taken at branches (services), stubs (blow offs) and not more than 300 m apart along the length of the watermain. A sample of the distribution supply water shall also be taken. The watermain shall not be flushed or disturbed during the minimum 24-hour period between sets of samples. All samples shall be collected and delivered to an accredited lab by municipal staff to be analysed. Refer to the Essential Supplies and Services List (PENQMS 13-1) for an accredited lab (special accommodations may need to be made).

2.26 All samples shall be analyzed for the following along with the Maximum Allowable Concentrations:

E.Coli	0
Total Coliforms	0
Background Colonies	Less than 200 CFU/100ml

Final Connection

2.27 The contractor will be permitted to make the final connection(s) once it has satisfied all of the above sections and the Town has granted its approval. These



connections shall be witnessed by authorized Water Division staff and/or the site inspector.

- 2.28 All watermain and appurtenances used in completing the final connection must be thoroughly cleaned and disinfected with a 1% sodium hypochlorite solution.
- 2.29 If at any time, trench water or foreign objects enter any portion of the new watermain, the entire disinfection and sampling procedures shall be repeated.

Commissioning

- 2.30 Before commissioning the new watermain there are a number of other items that must be checked which include:
 - Tracer wire locations and conductivity. Water Division staff shall ensure that tracer wire leads are visible inside every valve box, water service and ensure the tracer wire is connected to a flange bolt on every fire hydrant. Tracer wire conductivity shall also be checked by the Water Division staff by line tracing the entire watermain and services.
 - Fire hydrants shall be inspected for proper operation and physical condition which include paint condition and tracer wire termination to a bolt on breaking flange.
 - Valve operation and box conditions shall be checked and noted.



New Watermain Testing Procedure _ Appendix "A"

NEW WATERMAIN TEMPORARY CONNECTION

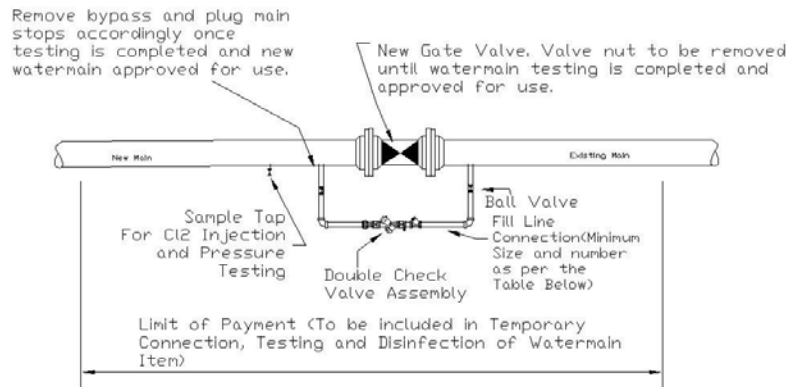

Pipe Diameter	Flow Required to produce 2.5ft/s (0.76m/s) (approx.) Velocity in Main	Size of Tap in. (mm)			Number of Open 2½in. (64mm) Hydrant Outlets
		1 (25)	1½ (38)	2 (51)	
In. - mm	Gpm - l/s	Number of Taps on Pipe			
4 - 100	100 - 6.3	1	-	-	1
6 - 150	200 - 12.8	-	1	-	1
8 - 200	400 - 25.2	-	2	1	1
10 - 250	600 - 37.9	-	3	2	1
12 - 300	900 - 56.8	-	-	2	2
16 - 400	1600 - 109.9	-	-	4	2

REQUIRED FLOW AND OPENINGS TO FLUSH PIPELINES (276kPa/40 PSI RESIDUAL PRESSURE IN WATERMAIN)
 A MINIMUM VELOCITY OF 2.5ft/s (0.76m/s) WHEREVER POSSIBLE TO ALLOW FOR PROPER FLUSHING.

TOWN OF PENETANGUISHENE		DRAWN BY M. LeFaive	REV
SCALE N.T.S.	DATE FEBRUARY 16th, 2007	FILE NAME New Watermain Temporary Connection.dwg	



New Watermain Testing Procedure _ Appendix "B"

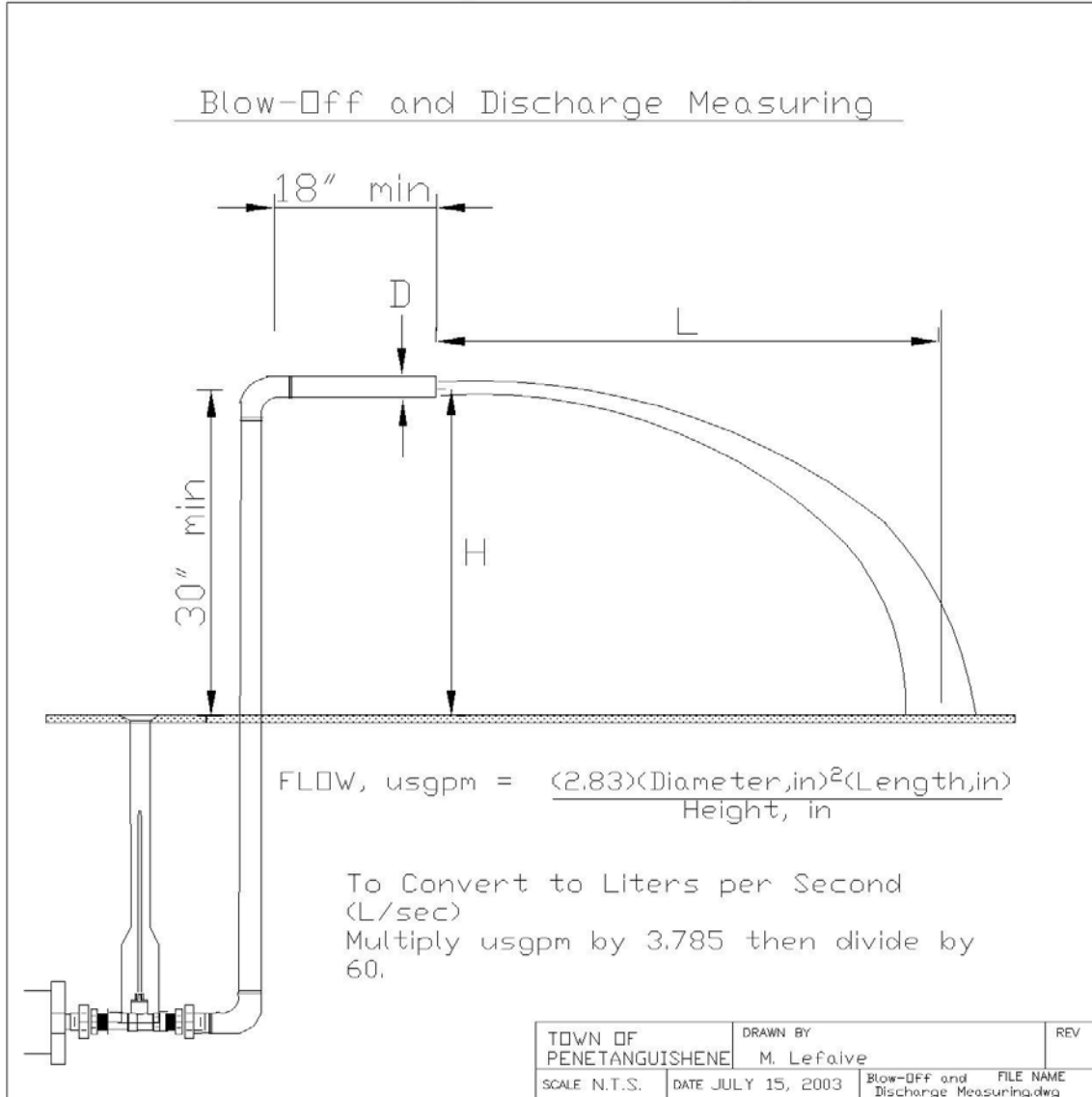

3. REFERENCES

- Ontario Watermain Disinfection Procedure
- AWWA B300
- PENQMS 13-1 Essential Supplies and Services List
- Watermain Testing Tools
- PENQMS 15-12 Watermain Commissioning Check List

The Town of Penetanguishene Water Division
Document Title: Watermain Commissioning Checklist
Revision: 1
WQMS Reference: PENQMS 15-12



Date: _____

Subdivision: _____

Project: _____

Contractor: _____

Consulting Engineer: _____

Item	Work Description	Work Performed By	Comments	Witnessed By
1	Watermain and appurtenances constructed to Town's specifications.	Consultant / Town		
2	Appurtenance Checks (isolation gate valves operated and condition verified)	Town		
3	Loading of Watermain	Consultant / Town		
4	Swabbing	Consultant / Town		
5	Flushing (Turbidity < 5 NTU)	Consultant / Town		
6	Hydrostatic Leakage Testing	Contractor / Town		
7	Disinfecting Watermain (residual 50mg/l)	Contractor/Town		
8	24-hour Check (min 25mg/l residual)	Consultant/Town		
9	Removal and disposal of Superchlorinated Water (until Free Cl ₂ residual is consistent with the Town's distribution system)	Contractor		
10	Initial Samples (24 hours after above item)	Town		
11	Second Samples (24 hours after first sample)	Town		
12	Sample Results	Town		
13	Final Connection(s)	Contractor/Town		
14	Tracer Wire Conductivity	Town		
15	Valve Box Condition	Town		
16	Fire Hydrant Condition	Town		

Ac

Additional Comments:

*WATERMAIN FORM 1
CHECKLIST*

Engineering and Form 1 Checklist

Requirement	Reference	Completed (Y/N)
General		
Pre-Consult with Town water department regarding water model for existing flows / watermain capacity.	Town Std.	
Watermain Designed to convey greater of Maximum Daily Demand + Fire Flow or Peak Hour Demand	Town Std.	
Town Material List Included in Drawing Notes	Town Std.	
Watermain Looped	Town Std.	
Watermain & Sewer Separation achieved	MOECP	
Location Town Standard Road Section	Town Std.	
Cathodic Protection Notes	Town Std.	
Watermain Bedding	OPSS & OPSD	
Hydrant and Valve Spacing	Town Std.	
Air Release and Drain Chambers (Site Specific)	Town Std.	
Service Connections: Residential: 25mm Commercial / Institutional / Industrial: Sized per Demand	Town Std.	
Note included on Drawing "All chemicals and materials used in the alteration or operation of the drinking water system that come into contact with water within the system shall meet all applicable standards set by both the American Water Works Association ("AWWA") and the American National Standards Institute ("ANSI") safety criteria standards NSF/60, NSF/61 and NSF/372."	Town Std.	
Design Requirements		
	Criteria / Results	Completed
Average daily demand: 350 litres/capita/day Maximum daily demand factor: 1.9 Peak hourly demand factor: 2.85		
FUS calculations, or Town Standard Minimum flows, whichever is greater.		
Hazen-Williams C-Factors per Town Standard		
Hydrant Spacing: Residential Subdivisions - 150m Industrial / Commercial / Site Plans - 90m		
Minimum & Maximum Depth of Cover: Minimum 1.7m Maximum 2.5m		
Tracer Wire: 12ga		
Design Results		
	Criteria / Results	Completed
Maximum Velocity <= 5.0m/s	MECP	

Requirement	Reference	Completed (Y/N)
Pressure Ranges		
Avg & Max Day: 350kPa - 550kPa	MECP	
Min & Peak Hour: 275 kPa - 700kPa	MECP	
Max. Day + Fire Flow: 140kPa - 400 kPa	MECP	
Name (print): _____ Date: _____		
Signature: _____		